

Dell™ PowerVault™ 715N NAS Systems Administrator's Guide

[Initial Configuration](#)

[NAS Manager](#)

[Advanced Disk and Volume Management](#)

[Backing Up the System](#)

[Recovering and Restoring the System](#)

[Dell ActiveArchive](#)

[Advanced Features](#)

[Troubleshooting](#)



NOTE: A NOTE indicates important information that helps you make better use of your computer.



NOTICE: A NOTICE indicates either potential damage to hardware or loss of data and tells you how to avoid the problem.



CAUTION: A CAUTION indicates a potential for property damage, personal injury, or death.

Information in this document is subject to change without notice.

© 2001–2002 Dell Computer Corporation. All rights reserved.

Reproduction in any manner whatsoever without the written permission of Dell Computer Corporation is strictly forbidden.

Trademarks used in this text: *Dell*, the *DELL* logo, *PowerVault*, *Dell OpenManage*, and *Dell ActiveArchive* are trademarks of Dell Computer Corporation; *Microsoft*, *MS-DOS*, *Windows*, and *Windows NT* are registered trademarks of Microsoft Corporation; *Novell* and *NetWare* are registered trademarks of Novell, Inc.; *VERITAS* and *Backup Exec* are registered trademarks of VERITAS Software; *UNIX* is a registered trademark of The Open Group of the United States and other countries; *Intel* is a registered trademark of Intel Corporation; *Computer Associates* is a registered trademark and *ARCserveIT* is a trademark of Computer Associates International.

Other trademarks and trade names may be used in this document to refer to either the entities claiming the marks and names or their products. Dell Computer Corporation disclaims any proprietary interest in trademarks and trade names other than its own.

Initial release: 26 Mar 2002

Initial Configuration

Dell™ PowerVault™ 715N NAS Systems Administrator's Guide

- [Configuring the NAS System for the First Time](#)
- [Other Documents You Might Need](#)

This section provides information necessary to perform the initial configuration of the system.

The NAS system is a "headless" system that is managed through the network; it operates without a keyboard, monitor, or mouse. You configure and manage the NAS system with the browser-based Dell™ PowerVault™ NAS Manager, which runs on a client system on the same network. See "[NAS Manager](#)" for more information. For certain configuration tasks and for troubleshooting, you can connect the client system directly to the NAS system using the serial cable that was provided with the NAS system.

Configuring the NAS System for the First Time

You must set the basic configuration from another system that has a keyboard, monitor, and mouse. This system is referred to as the client system. After you set the basic configuration, you can use the NAS Manager from any system on the network to set passwords, local users, shares, and so on. See "[NAS Manager](#)."

You can configure your system in several ways, depending on whether you use Dynamic Host Configuration Protocol (DHCP):

- If DHCP is installed on your network, your system automatically configures the network settings. Contact your network administrator if you do not know whether your network uses DHCP.
- If DHCP is not installed on your network, you can configure your system using a serial connection or the Dell OpenManage™ Kick-Start utility.

Configuring Your System Automatically on a Network (with DHCP)

1. Connect the power cable to the NAS system, and plug the cable into a power source.
2. Connect one end of an Ethernet cable (see [Figure 1-1](#)) into the port labeled "LAN 1" on the back of your NAS system.

 **NOTE:** Your NAS system was shipped with a standard Ethernet cable and a crossover Ethernet cable. Do not use the crossover cable. The crossover cable is used only for reinstallation.

3. Connect the other end of the Ethernet cable to a functioning Ethernet jack.
4. Push the power button to turn on the NAS system.

 **NOTE:** The NAS system takes approximately 5 minutes to boot.

The NAS system retrieves the information it needs (the Internet protocol (IP) address, gateway subnet mask, and domain naming system (DNS) server address) from another system on the network.

Figure 1-1. Ethernet Cable

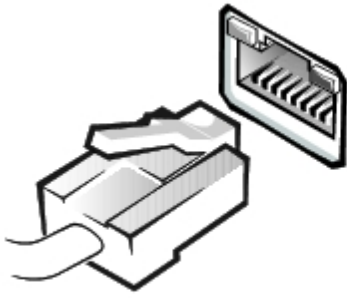

5. Verify that the LAN 1 LED on the bezel is lit.

If the LED is not lit, check to make sure that the Ethernet cable is connected and that your network connection is functioning properly.

6. From a client system on the same network, open Microsoft® Internet Explorer 5.01 or later (or for Red Hat Linux only, open Netscape Navigator 6.1 or later), type the default system name in the URL box, and press <Enter>.

The default system name is `DELLxxxxxxx`, where `xxxxxxx` is the system's service tag number. For example, if your service tag number is 1234567, type `DELL1234567`. You can find the service tag number on the top cover of your NAS system.

7. If you cannot connect to the system through a Web browser, set the IP address, gateway subnet mask, and DNS server using either a serial connection or the Kick-Start utility with DHCP on a remote system.

See "[Configuring Your System Using a Serial Connection](#)" and follow the procedure for your operating system, or see "[Discovering Your System Using the Kick-Start Utility](#)."

8. Enter the default administrative user name and password for your system when prompted, and then click **OK**.

 **NOTE:** The default administrative user name is `administrator` and the default password is `powervault`.

9. Use the NAS Manager to begin setting up shares and volumes on the NAS system.

See "[NAS Manager](#)."

-  **NOTICE:** If you do not use the Kick-Start utility to configure your system, you must disable the Kick-Start utility immediately. If the Kick-Start utility is enabled, the system logs in automatically as administrator, which creates a security risk. The Kick-Start utility also takes up system resources by constantly checking for configuration information. For more information, see "[Disabling the Kick-Start Utility](#)."

Configuring Your System Using a Serial Connection

If your network does not have DHCP, you can configure your NAS system using a serial connection. You can connect to the NAS system by using a client system with one of the following operating systems:

- Microsoft Windows NT®
- Windows® 2000
- Windows XP

Configuring Your System Using a Serial Connection (Windows 2000 Client)

 **NOTE:** Perform this procedure only if you cannot configure your NAS system by using a DHCP server on the network. See "[Configuring Your System Automatically on a Network \(with DHCP\)](#)."

Setting Up the Windows 2000 Client for the First Time

1. Connect one end of the serial cable provided with your NAS system (see [Figure 1-2](#)) to the serial port on the NAS system, and connect the other end to an available serial port (typically COM1 or COM2) on a client system running Windows 2000.

Figure 1-2. Serial Cable

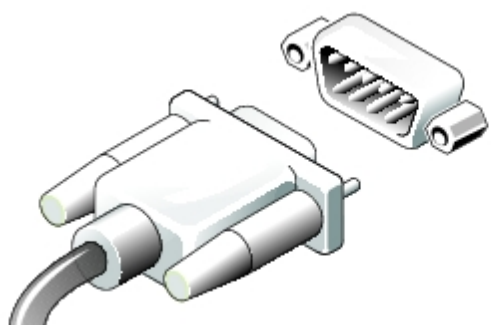

2. Plug in the NAS system.
3. Push the power button to turn on the NAS system.

 **NOTE:** The NAS system takes approximately 5 minutes to boot. You should allow an additional 5 minutes for the serial connection service on your NAS system to start.

4. Right-click **My Network Places** on the desktop, and click **Properties**.

The **Network and Dial-up Connections** window appears.

5. Double-click **Make New Connection**.

The Network Connection Wizard is displayed.

6. Click **Next**.
7. Select **Connect Directly To Another Computer**, and then click **Next**.
8. Select **Guest**, and then click **Next**.
9. From the **Select a Device** menu, select the COM port on your client system to which you connected the serial cable, and then click **Next**.

The COM port is the communication port on the client system to which the serial cable connects. The COM port used on your client system is typically labeled COM1 or COM2.

10. Click **Only for myself**, and then click **Next**.
11. Type a name for the connection in the text box, and then click **Finish**.

Do *not* click **Connect** yet. The connection must be set up before connecting.

 **NOTE:** It may take several minutes for the direct serial connection setup to complete.

12. Click **Properties**.
13. In the next window that appears, click the **General** tab, and then select **Communication cable between two computers** in the **Select a Device** section.
14. Click **Configure**.

The **Modem Configuration** window appears.

15. Select the **Maximum Speed (bps)** menu, and then click **115200**.
16. Verify that only **Enable hardware flow control** is selected.
17. Click **OK** to close the **Modem Configuration** window.

18. Click **OK** to close the connection window.

The **Connect** box prompts you for a user name and password.

 **NOTE:** The default administrative user name is `administrator` and the default password is `powervault`.

19. Ensure that your NAS system is on and that it has had sufficient time to boot into the Windows operating system.
20. Start a Web browser on the client system you are using to configure the NAS system.
21. Type `https://192.168.192.1:1279` in the browser and press <Enter>.

192.168.192.1 is the IP address used by your NAS system for this serial cable connection.

22. Click **Yes** to accept the security certificate.

If a message states that the name on the security certificate is invalid or does not match the name of the site, ignore the message and click **Yes**.

23. Enter the administrative user name and password for your system when prompted, and then click **OK**.

 **NOTE:** The default administrative user name is `administrator` and the default password is `powervault`.

The NAS Manager is displayed. After the NAS Manager is displayed, you can configure your system through the NAS Manager or through the Terminal Service Client. See "[Configuring the IP Address](#)" in "NAS Manager."

Connecting to the NAS System

This section assumes that you have already configured your client system to connect to the NAS system. If you have not configured the client system, see "[Setting Up the Windows 2000 Client for the First Time](#)."

1. Ensure that your NAS system is on and that it has had sufficient time to boot into the Windows operating system.

 **NOTE:** The NAS system takes approximately 5 minutes to boot. You should allow an additional 5 minutes for the serial connection service on your NAS system to start.

2. On the client system that is connected to the NAS system, right-click **My Network Places** on the desktop, and click **Properties**.

The **Network and Dial-up Connections** window appears.

3. Double-click the connection you created in "[Setting Up the Windows 2000 Client for the First Time](#)."
4. Enter the administrative user name and password for your NAS system.

 **NOTE:** The default administrative user name is `administrator` and the default password is `powervault`.

5. Click **Connect**.

This action connects the client system to the NAS system through the serial cable.

6. Start a Web browser on the client system you are using to configure the NAS system.
7. Type `https://192.168.192.1:1279` in the browser and press <Enter>.

192.168.192.1 is the IP address used by your NAS system for this serial cable connection.

8. Click **Yes** to accept the security certificate.

If a message states that the name on the security certificate is invalid or does not match the name of the site, ignore the message and click **Yes**.

9. Enter the administrative user name and password for your system when prompted, and then click **OK**.

 **NOTE:** The default administrative user name is `administrator` and the default password is `powervault`.

The NAS Manager is displayed.

After the NAS Manager is displayed, you can configure your system through the NAS Manager or through the Terminal Service Client. See "[Configuring the IP Address](#)" in "NAS Manager."

Configuring Your System Using a Serial Connection (Windows XP Client)

 **NOTE:** Perform this procedure only if you cannot configure your NAS system by using a DHCP server on the network. See "[Configuring Your System Automatically on a Network \(with DHCP\)](#)."

Setting Up the Windows XP Client for the First Time

1. Connect one end of the serial cable provided with your NAS system (see [Figure 1-2](#)) to the serial port on the NAS system, and connect the other end to an available serial port (typically COM1 or COM2) on a client system running Windows XP.
2. Plug in the NAS system.
3. Push the power button to turn on the NAS system.

 **NOTE:** The NAS system takes approximately 5 minutes to boot.

4. Click the **Start** button and click **Control Panel**.
5. Click **Network and Internet Connections**.
6. Click **Network Connections**.
7. Click **Create a new connection** in the left pane.
8. In the **New Connection** window, click **Next**.
9. Click **Set up an advanced connection**, and then click **Next**.
10. Select **Connect Directly To Another Computer**, and then click **Next**.
11. Select **Guest**, and then click **Next**.
12. Type a name for the connection to the NAS system in the **Computer Name** field.
13. From the **Select a Device** menu, select the COM port on your client system to which you connected the serial cable, and then click **Next**.

The COM port is the communication port on the client system to which the serial cable connects. The COM port used on your client system is typically labeled COM1 or COM2.

14. Click **Add a shortcut to this connection to my desktop**, and click **Finish**.

Connecting to the NAS System

This section assumes that you have already configured your client system to connect to the NAS system. If you have not configured the client system, see "[Setting Up the Windows XP Client for the First Time](#)."

1. Ensure that your NAS system is on and that it has had sufficient time to boot into the Windows operating system.

 **NOTE:** The NAS system takes approximately 5 minutes to boot. You should allow an additional 5 minutes for the serial connection service on your NAS system to start.

2. From the desktop of the client system, double-click the icon for the connection to the NAS system.
3. In the **Connect** window, click **Properties**.
4. In the **Properties** window, click **Configure**.
5. In the **Modem Configuration** window, select **115,200** for **Maximum speed (bps)** and click **OK**.
6. Click **OK** again to close the **Properties** window.
7. Enter the administrative user name and password for your NAS system.

 **NOTE:** The default administrative user name is `administrator` and the default password is `powervault`.

8. Click **Connect**.

This action connects the client system to the NAS system through the serial cable.

9. Start a Web browser on the client system you are using to configure the NAS system.
10. Type `https://192.168.192.1:1279` in the browser and press <Enter>.

192.168.192.1 is the IP address used by your NAS system for this serial cable connection.

11. Click **Yes** to accept the security certificate.
12. Enter the administrative user name and password for your system when prompted, and then click **OK**.

 **NOTE:** The default administrative user name is `administrator` and the default password is `powervault`.

The NAS Manager is displayed.

After the NAS Manager is displayed, you can configure your system through the NAS Manager or through the Terminal Service Client. See "[Configuring the IP Address](#)" in "NAS Manager."

Configuring Your System Using a Serial Connection (Windows NT Client)

 **NOTE:** Perform this procedure only if you cannot configure your NAS system by using a DHCP server on the network. See "[Configuring Your System Automatically on a Network \(with DHCP\)](#)."

Setting Up the Windows NT Client System for the First Time

1. Connect one end of the serial cable provided with your NAS system (see [Figure 1-2](#)) to the serial port on the NAS system, and connect the other end to an available serial port (typically COM1 or COM2) on a client system running Windows NT.
2. Plug in the NAS system.
3. Push the power button to turn on the NAS system.

 **NOTE:** The NAS system takes approximately 5 minutes to boot. You should allow an additional 5 minutes for the serial connection service on your NAS system to start.

4. Turn on the client system and log in as an administrator.
5. Install the modem on the client system:
 - a. Insert the Microsoft Windows NT 4.0 operating system CD into the CD drive of the client system.
 - b. Close the **Windows CD-ROM** menu when it displays.
 - c. From the desktop, double-click **My Computer**.
 - d. In the **My Computer** window, double-click **Dial-Up Networking**.

- e. Click **Install**.
 - f. When asked if you want to be able to add a modem, click **Yes**.
 - g. In the **Install New Modem** window, select **Don't detect my modem; I will select it from a list**.
 - h. Click **(Standard Modem Types)**, and then click **Dial-Up Networking Serial Cable between 2 PCs**.
 - i. Click **Next**.
 - j. Select the port to which you want to install the modem, and then click **Next**.
 - k. Enter the area code in the **Localization Information** window, and then click **Next**.
 - l. Click **Finish** to complete the modem installation.
 - m. In the **Add RAS Device** window, click **COMx - Dial-Up Networking Serial Cable Between 2 PCs**, and click **OK**.
 - n. In the **Remote Access Setup** window, select **Dial-Up Networking Serial Cable between 2 PCs**, and click **OK**.
 - o. Click **Dial out only** and click **OK**.
 - p. In the **Remote Access Setup** window, select **Dial-Up Networking Serial Cable between 2 PCs**, and click **Network**.
 - q. Deselect NetBEUI and IPX as dial-out protocols, make sure that TCP/IP is selected, and click **Configure**.
 - r. Click **Continue**.
 - s. Remove the Windows NT CD from the CD drive.
 - t. Click **Restart**.
6. Log in to the client system as an administrator.
7. Configure the modem properties:
- a. From the client desktop, double-click **My Computer**.
 - a. Double-click **Control Panel**.
 - b. In the **Control Panel** window, double-click **Modems**.
 - c. For **Modem Properties**, select **Dial-Up Networking Serial Cable Between 2 PCs**.
 - d. Click **Properties**.
 - e. Select **115,200** for **Maximum speed** and click **OK**.
 - f. Click **Close**.
8. Create the dial-up connection to the NAS system:
- a. In the **My Computer** window, double-click **Dial-Up Networking**.
 - b. When a message states that your phonebook is empty, click **OK** to create a new phone book entry.
 - c. In the New Phonebook Entry Wizard, type a name for the connection to the NAS system.
 - d. Click **I know all about phonebook entries and would rather edit the properties directly**, and then click **Finish**.
 - e. Click **Configure**.
 - f. Select **115,200** for the **Initial Speed** and click **OK**.
 - g. Click the **Server** tab, and deselect **NetBEUI** and **IPX**.

TCP/IP should be the only protocol selected.

- h. Click **OK**.

Connecting to the NAS System

This section assumes that you have already configured your client system to connect to the NAS system. If you have not configured the client system, see "[Setting Up the Windows NT Client System for the First Time](#)."

1. Ensure that your NAS system is on and that it has had sufficient time to boot into the Windows operating system.

 **NOTE:** The NAS system takes approximately 5 minutes to boot. You should allow an additional 5 minutes for the serial connection service on your NAS system to start.

2. From the desktop of the client system, double-click the icon for the connection to the NAS system.

3. Dial into the NAS system:

- a. In the **Dial-Up Networking** window, click **Dial**.

- b. Type the administrative user name, password, and domain for your NAS system when prompted, and then click **OK**.

 **NOTE:** The default administrative user name is `administrator` and the default password is `powervault`. For domain, enter the NAS system's name. The default system name is `DELLxxxxxxx`, where `xxxxxxx` is the system's service tag number. For example, if your service tag number is 1234567, type `DELL1234567`. You can find the service tag number on the top cover of your NAS system.

- c. Start a Web browser on the client system you are using to configure the NAS system.

- d. Type `https://192.168.192.1:1279` in the browser and press `<Enter>`.

192.168.192.1 is the IP address used by your NAS system for this serial cable connection.

- e. Click **Yes** to accept the security certificate.

- f. Enter the administrative user name and password for your system when prompted, and then click **OK**.

 **NOTE:** The default administrative user name is `administrator` and the default password is `powervault`.

The NAS Manager is displayed.

After the NAS Manager is displayed, you can configure your system through the NAS Manager or through the Terminal Service Client. See "[Configuring the IP Address](#)" in "NAS Manager."

Discovering Your System Using the Kick-Start Utility

 **NOTE:** Perform the procedures in this section only if you cannot configure your NAS system using a DHCP server on the network. See "[Configuring Your System Automatically on a Network \(with DHCP\)](#)."

1. Plug in the NAS system.
2. Connect one end of an Ethernet cable (see [Figure 1-1](#)) into the port labeled "LAN 1" on the back of your NAS system.

 **NOTE:** Do not use the Ethernet crossover cable that was shipped with the NAS system.

3. Connect the other end of the Ethernet cable to a functioning Ethernet jack.
4. Connect a client system running Windows 2000 to a functioning Ethernet jack.
5. Enable the Dell OpenManage Kick-Start utility and create your DHCP settings:
 - a. Insert the *Resource* CD into the CD drive of the client system.

- b. When the *Resource* CD window displays, click **Kick-Start**.
 - c. Click **Run Dell OpenManage Kick-Start**.
 - d. If a security warning appears, click **Yes**.
 - e. When asked if you want to run the program, click **Yes**.
 - f. At the bottom of the **Dell OpenManage Kick-Start** window, click **Setup**.
 - g. Click **Add**.
 - h. In the **Add Scope** window, type the following information and click **OK**:
 - o **Starting IP Address:** 10.40.10.10
 - o **Ending IP Address:** 10.40.10.20
 - o **Subnet:** 255.255.255.0
 - o **Gateway IP Address:** 10.40.10.1
 - i. Click **OK** to close the **Add Scope** window.
 - j. Click **Interfaces for DHCP Server** so that it is checked.
 - k. Click **OK** to close the **Setup** window.
6. Click **Enabled** at the bottom of the **Dell OpenManage Kick-Start** window to start the integrated DHCP server.
 7. Click **OK** to close the **Add Scope** window.
 8. Turn on the NAS system.

When the system completes booting, it is displayed in the **Discovered Systems** list of the **Dell OpenManage Kick-Start** window.



NOTE: The NAS system takes approximately 5 minutes to boot.

9. Click the NAS system in the **Discovered Systems** list.
10. Click **Launch Configuration Tool** to launch the NAS Manager.

The **Configuring** icon is displayed for 5 minutes after you click **Launch Configuration Tool**. If the agent is still running after 5 minutes, the icon displays "Ready."



NOTE: The Kick-Start automatic configuration tool is not supported on the PowerVault 715N.

11. Use the NAS Manager to configure the NAS system's IP address.

See "[Configuring the IP Address](#)" in "NAS Manager."

Disabling the Kick-Start Utility

If you do not use the Kick-start utility to configure your system, you must disable it immediately. If the Kick-Start utility is enabled, the system logs in automatically as administrator, which creates a security risk. The Kick-Start utility also takes up system resources by constantly checking for configuration information.

To disable the Kick-Start utility, perform the following steps:

1. From the NAS Manager primary menu, click **Maintenance**.
2. Click **Terminal Services**.
3. Log in to the system as an administrator.

 **NOTE:** The default administrative user name is `administrator` and the default password is `powervault`.

4. When asked if you want to disable the Kick-Start Agent, click Yes to disable the Kick- Start Agent and prevent it from running again, or click **No** if you want the Kick-Start Agent to continue running and also run when the system reboots.

Other Documents You Might Need

[Table 1-1](#) lists the additional documentation included with your system.

Table 1-1. Other Documents

Document	Type of Information
<i>User's Guide</i>	System features, technical specifications, and device drivers.
<i>Installation and Troubleshooting Guide</i>	Instructions for installing system hardware and troubleshooting and diagnostic procedures for testing your system.
<i>System Information</i>	Basic information about your system, including safety and regulatory information. Warranty information may be in this document or as a separate document.
<i>Resource CD</i>	Electronic copies of your system documentation and documentation for options such as NICs.
Readmes and Release Notes	Last-minute updates about technical changes to the system or advanced technical reference material intended for experienced users or technicians.
Information Updates	Documents that are sometimes included with the system to describe changes to the system or software documentation. Always read the updates before consulting any other documentation. The updates often contain information that supersedes the information in the other documents.

[Back to Contents Page](#)

NAS Manager

Dell™ PowerVault™ 715N NAS Systems Administrator's Guide

- [Logging in to the NAS Manager](#)
- [Basic Navigation](#)
- [Changing the NAS Manager Language](#)
- [How to Find Online Help](#)
- [Configuring Network Properties](#)
- [Creating Users](#)
- [Using Shares](#)
- [Disk Quotas](#)
- [Using Logs](#)
- [Shutting Down the NAS System](#)
- [Managing Disks](#)
- [Managing Volumes](#)
- [Using the PowerVault Advanced Administration Menu](#)

The Dell™ PowerVault™ NAS Manager is a Web-based user interface that is the primary way to configure NAS systems. This section describes basic navigation of the NAS Manager.

Logging in to the NAS Manager

To use the NAS Manager, you must be logged in as an administrator. You can log in only if the NAS system is on the network or if you are connected directly to the NAS system with a serial cable.

To log in to the NAS Manager, perform the following steps:

1. Open a Web browser.

The NAS Manager is compatible with clients running Microsoft® Internet Explorer 5.01 or later (for Red Hat Linux only, Netscape Navigator 6.1 or later).

2. Type in the name of the NAS system in the URL box, and then press <Enter>.

The default system name is Dellxxxxxx, where xxxxxx is the system's service tag number. For example, if your service tag number is 1234567, enter DELL1234567. You can find the service tag number on the top cover of your NAS system.

The NAS Manager is served on port 1279 and is accessed by the following URL: **https://systemname:1279** or **https://system_ipaddress:1279**, where *systemname* is Dellxxxxxx and xxxxxx is the system's service tag number. For example, if your service tag number is 1234567, you would enter `https://DELL1234567:1279`. Port 1279 uses secure socket layer (SSL) to encrypt data going to and coming from the NAS system to provide data security.

 **NOTICE:** Although port 1278 can be used, it uses plain text authentication, which can be a significant security risk. Therefore, using port 1278 is not recommended.

3. When the **Enter Network Password** window displays, type a user name and password and then click **OK** to log in as the administrator.

 **NOTE:** The NAS Manager default administrator user name is `administrator` and the default password is `powervault`.

4. Click the **Administer this server appliance** link.
5. When the **Enter Network Password** window appears again, enter the same user name and password that you

entered in step 3, and then click **OK**.

You are now logged in to the NAS Manager.

Basic Navigation

When navigating the NAS Manager, use the buttons within the program to go backward and forward.

The top of each page of the Web user interface (UI) is composed of a status area, as well as primary and secondary menu bars. The body of each page of the UI is composed of the content area.

Status Area

The following information is displayed from left to right:

- System host name
- System status

The status types are:

- Normal (green text)
- Informational (grey text)
- Warning (yellow text)
- Critical (red text)

Clicking **Status:** *<status_type>* sends you to the **Status® Information** page.

- Microsoft Windows® Powered logo

Primary Menu

The primary menu has the following tabs:

- **Welcome** — Allows you to take a tour and set the administrator password, NAS system name, and default page.
 - **Status** — Provides information about alerts and other status.
 - **Network** — Provides access to basic network setup tasks such as setting the NAS system name, configuring properties of network interfaces, configuring global network settings, setting IP addresses and ports for the administration website, configuring Telnet, and changing passwords.
 - **Disks** — Allows you to configure disks and volumes, set disk quotas, and take persistent images.
 - **Users** — Enables you to manage local users and groups.
 - **Shares** — Enables you to manage local folders and create or modify file shares.
 - **Maintenance** — Allows you to perform maintenance tasks such as backup and restore, apply software updates, check logs, change the language of the NAS Manager, and access the Terminal Services Advanced Client.
 - **Help** — Provides access to online Help for network attached storage.
-

Changing the NAS Manager Language

The NAS Manager is available in different languages. To change the NAS Manager language, perform the following steps:

1. Log in to the NAS Manager.

See "[Logging in to the NAS Manager.](#)"

2. Click **Maintenance**.
3. Click **Language**.
4. Click the radio button next to the language you want to use.
5. Click **OK**.
6. Reboot the system when prompted.

The NAS system reboots, and the he changes are complete after the reboot.

How to Find Online Help

The NAS Manager provides two kinds of help. The NAS Manager online help documents the NAS Manager content. The Windows 2000 help, which you can access through the Terminal Services on the **Maintenance** page, documents Windows 2000 content.

To access Help in the NAS Manager, select one of the following methods:

- When you click **Help** on the primary menu, the NAS Manager screen is replaced by a split **Help** screen that has the Table of Contents of help topics on the left and the topic content on the right.
- Click the question mark icon at the far right of the primary menu to access the context-sensitive help topic related to the current page.

In addition to the online help for your system, you can also access help for Microsoft Windows 2000 through Terminal Services.

To start Windows 2000 help, perform the following steps:

1. Log in to the NAS Manager.

See "[Logging in to the NAS Manager.](#)"

2. Click **Maintenance**.
3. Click **Terminal Services**.
4. Log in to the NAS system.



NOTE: The default administrative user name is `administrator` and the default password is `powervault`.

5. Perform one of the following procedures:
 - From the **Start** menu, click **Help**.
 - On the Advanced Administration Menu, click **Administrative Tools**, and then click **Windows Powered Help**.
-

Configuring Network Properties

Use the **Network** tab in the NAS Manager to configure the NAS system for the network. This section provides information for setting up your NAS system on the network, including naming the system, defining the IP address, and configuring the NIC.

Naming the NAS System

By default, the NAS system uses your service tag number as the system name. To change the name of the NAS system, perform the following steps:

1. Log in to the NAS Manager.

See "[Logging in to the NAS Manager.](#)"

2. Click **Network**.
3. Click **Identification**.
4. Type a new name for the NAS system in the **Server appliance name** field.
5. Click **OK**.
6. Click **OK** to reboot, or click **Cancel** to not reboot.

Until you reboot the system, the new name will not take effect. Use the new name when you connect to the NAS Manager.

Configuring the IP Address

If you have DHCP you do not have to configure your NAS system's IP address because DHCP automatically assigns an address to the NAS system. If you do not have a DHCP server on your network, you must set the address for the NAS Appliance through the NAS Manager.

 **NOTE:** Before you configure the IP address, make sure that the NAS system is connected to the network by plugging an Ethernet cable into the correct Ethernet port.

To configure the IP address, perform the following steps:

1. Log in to the NAS Manager.

See "[Logging in to the NAS Manager.](#)"

2. Click **Network**, and then click **Interfaces**.
3. Select the radio button beside the network connection that you want to configure.

For example, if your Ethernet cable is connected to LAN1, click **Local Area Connection**.

 **NOTE:** If some of the text is missing due to column width, hover your mouse over the text for a full description.

4. Click **IP**, and select **Use the following IP settings**.
5. Enter the desired IP address, subnet mask, and default gateway.

If you do not know this information, contact your system administrator.

6. Click **OK**.

The network address setup is complete.

 **NOTE:** When you change the IP address, the NAS Manager might become unavailable either until you reboot the NAS system or for approximately 15 minutes until the network recognizes the new IP address. You can also try to access the NAS system by typing `https://new_ip_address:1279` in the NAS Manager.

Creating Users

A user is a person or group that has access to the shares on the NAS system. You create users after you configure the network properties of your NAS system.

Creating a Single Local User

 **NOTE:** In a domain environment, you cannot create domain users.

1. Log in to the NAS Manager.

See "[Logging in to the NAS Manager.](#)"

2. Click **Users**.
3. Click **Local Users**.
4. On the **Local Users on Server Appliance** page, click **New**.
5. Complete the information on the **Create New User** page.

 **NOTE:** In a domain environment, do not create local users that have the same user name as domain users unless the local user and domain user have identical passwords.

The **Home Directory** text box specifies a new directory that will be created and to which the user will have exclusive access permission. The directory name is the same as the user name and is located in the path specified.

6. Click **OK**.

Creating a Local Group of Users

 **NOTE:** In a domain environment, you cannot create domain groups. However, you can add domain users to your local groups.

1. Log in to the NAS Manager.

See "[Logging in to the NAS Manager.](#)"

2. Click **Users**.
3. Click **Local Groups**.
4. On the **Local Groups on Server Appliance** page, click **New**.
5. On the **Create New Group** page, enter the name and description of the group.
6. Click **Members**.
7. Select the members for the group by performing one of the following:

- In the **Add user or group** box, select a local user or group from the list, and then click **Add**.
- Type the domain and group name (*domain\group_name*) of a domain group or of a domain user account (*domain\user_name*) and then click **Add**.

 **NOTE:** If you are adding a domain group, you must also enter the user name and password that will allow you to add from that domain.

8. Click **OK**.

Using Shares

A share is a folder on the NAS system that is shared with other systems on the network, whether those systems are running a Windows, Novell® NetWare®, Macintosh, or UNIX® operating system.

A NAS system supports the following methods of sharing folders:

- CIFS — The Common Internet File System protocol is used by clients running a Windows operating system.
- NFS — The Network File System protocol is used by clients running UNIX.
- FTP — The File Transfer Protocol is an alternative way of accessing a file share from any operating system.
- HTTP — The Hypertext Transfer Protocol is the protocol for accessing a file share from Web browsers.
- AppleTalk — The Appletalk protocol is used by clients running a Macintosh operating system.
- NCP (Novell NetWare) — The NCP protocol is used by NetWare clients.

 **NOTE:** The Appletalk and NCP protocols are disabled by default on the NAS system. See "[Advanced Features](#)" for information about enabling these protocols.

Adding a Share

To create a share, you must supply a share name that is different from all other shares on the system. This is the name that the client system uses to access the share. Some protocols also support the inclusion of a comment or brief description of the share. Additionally, you must enable at least one of the available protocols.

 **NOTICE:** Create your data shares on the data drives to make the shares more fault-tolerant.

To add a share, perform the following steps:

1. Log in to the NAS Manager.

See "[Logging in to the NAS Manager.](#)"

2. Click **Shares**.
3. On the **Shares** page, click **Shares**.
4. In the **Tasks** list on the **Shared Folders** page, click **New**.
5. Type the share name and share path.

 **NOTE:** Do not share the root directory of your system. Share only folders in the root directory. For example, do not share **d:**; instead, share **d:\foldername**, where *foldername* is the name of the folder in the root directory.

6. If you entered a nonexistent folder for in the **Share path**, click **Create folder if it does not already exist**.

 **NOTE:** The **Comment** field is ignored for NFS, FTP, and HTTP shares.

7. Check the appropriate box(es) to specify the types of protocols to enable. The available options are **Microsoft Windows (CIFS)**, **UNIX (NFS)**, **FTP**, **Web HTTP**, **Novell NetWare**, and **Apple Macintosh**.

If you want to use a protocol that is grayed out, you must first enable it on the NAS system. See "[Advanced Features](#)" for information about enabling the Appletalk and NCP protocols.

8. Use the protocol tabs to configure the specific properties of each type of share.

 **NOTE:** Services for NetWare (SFN) are compatible with Novell NetWare Bindery service for authentication and file access using the internetwork packet exchange/sequenced packet exchange (IPX/SPX) network protocol. You must perform a NetWare logon to the NAS system using a NetWare client before you can connect to the NetWare shares.

9. Click **OK**.

Modifying Share Properties

1. Log in to the NAS Manager.

See "[Logging in to the NAS Manager.](#)"

2. Click **Shares**.
3. On the **Shares** page, click **Shares**.
4. In the **Shared Folders** table, click the share whose properties you are modifying.
5. Click **Properties**.

The **Share Properties** page displays. Use this page to change the description of the share. You can also select the type of client from which the share is accessible.

6. Click **OK**.

Removing a Share

Although a single user interface is provided for creating a share for all protocols, a separate share is actually for each protocol. You can remove a share for one protocol without removing the share for the other protocols; however, this process can be quite confusing. Therefore, it must be done carefully.

When you remove a share, access to the share is removed; however, the actual files remain on the NAS system.

To remove a share, perform the following steps:

1. Log in to the NAS Manager.

See "[Logging in to the NAS Manager.](#)"

2. Click **Shares**.
3. On the **Shares** page, click **Shares**.
4. In the **Shared Folders** table, click the share that you want to delete.
5. Click **Delete**.

A confirmation dialog appears.

6. Click **OK** to confirm the deletion, or click **Cancel** to keep the share.

Removing a Protocol From the Share

To remove one or more specific protocols from a share, perform the following steps:

1. Log in to the NAS Manager.

See "[Logging in to the NAS Manager.](#)"

2. Click **Shares**.
3. On the **Shares** page, click **Shares**.
4. In the **Shared Folders** table, click the share for which you want to remove a protocol.
5. Click **Properties**.
6. Uncheck the protocol(s) to remove it from the share.
7. Click **OK** to confirm the protocol removal, or click **Cancel** to keep the protocol(s) for the share.

Disk Quotas

Disk quotas track and control the use of disk space for volumes. You can configure the volumes on your NAS system to do the following:

- Prevent further disk space use and log an event when a user exceeds a specified disk space limit.
- Log an event when a user exceeds a specified disk space warning level.

When you enable disk quotas, you can set both the disk quota limit and the disk quota warning level.

- The disk quota limit specifies the amount of disk space a user is allocated within a specific volume.
- The warning level specifies the point at which the event log displays that a user is nearing the quota limit within a specific volume.

For example, you can set a user's disk quota limit to 50 MB and the disk quota warning level to 45 MB. With these settings, the user can store no more than 50 MB on the volume. If the user stores more than 45 MB on the volume, you can set the disk quota system to log a system event to the event log.

In addition, you can specify a quota limit for the users but allow the users to exceed that quota limit. Enabling quotas and not limiting disk space use is useful when you want to track disk space use on a per-user basis but do not want to deny users access to a volume when they exceed that limit. You can also specify whether the system should log an event when a user exceeds either the quota warning level or the quota limit.

Enabling or Disabling Disk Quotas

To enable or disable quota management on a volume, perform the following steps:

1. Log in to the NAS Manager.

See "[Logging in to the NAS Manager.](#)"

2. Click **Disks**.
3. Click **Disk Quota**.
4. On the **Volumes and Quotas** page, click the volume to manage.
5. Click **Quota**.
6. On the **Default Quota for** volume page, click the appropriate check box to enable or disable quota management.
7. Select the quota size and settings for this volume.
8. Click **OK**.

Adding Disk Quota Entries

The **Quota Entries** page allows you to add, delete, or configure disk quotas for any user of the NAS system.

When you enable disk quotas for an existing volume, volume usage is automatically tracked for new users from that point on. However, existing volume users have no disk quotas applied to them. You can apply disk quotas to those existing volume users by adding new quota entries in the **Quota Entries** window.

To add a new quota entry, perform the following steps:

1. Log in to the NAS Manager.

See "[Logging in to the NAS Manager.](#)"

2. Click **Disks**.
3. Click **Disk Quota**.

4. On the **Disk Quota** page, click the volume to manage.
5. Click **Quota Entries**.
6. Click **New**.
7. Select a local user from the list box, or type the name of a domain account in the text box (in the format *domain_name\user_name*).
8. To allow unlimited disk space usage, click the **Do not limit disk usage** radio button, and then go to step 10. Otherwise, go to step 9.
9. To limit disk space, perform the following steps:
 - a. Click the **Limit disk space to** radio button.
 - b. In the text box, enter a numerical value to specify the amount of disk space to assign to a particular user or group. Use the drop-down box to select kilobytes (KB), megabytes (MB), gigabytes (GB), terabytes (TB), petabytes (PB), or exabytes (EB).
 - c. Enter the amount of disk space that, when filled, triggers a warning to the user or group member that the used disk space is near the disk-capacity limit. Use the drop-down box to select KB, MB, GB, TB, PB, or EB.
10. Click **OK**.

Modifying Quota Properties

1. Log in to the NAS Manager.

See "[Logging in to the NAS Manager](#)."

2. Click **Disks**.
3. Click **Disk Quota**.
4. On the **Disk Quota** page, click the volume to manage.
5. Click **Quota Entries**.
6. In the **Logon** list on the **Quota Entries** page for the selected volume, select a user account.
7. Click **Properties**.
8. On the **Quota entry for user** page, click the **Do not limit disk usage** radio button to allow unlimited disk use, or perform the following procedure to limit disk space:
 - a. Click the **Limit disk space to** radio button.
 - b. In the text box, enter a numerical value to specify the amount of disk space to assign to a particular user or group. Use the drop-down box to select **KB, MB, GB, TB, PB, or EB**.
 - c. Enter the amount of disk space that, when filled, triggers a warning to the user or group member that the used disk space is near the disk-capacity limit. Use the drop-down box to select **KB, MB, GB, TB, PB, or EB**.



NOTE: Any previously entered warning level does not appear in the text box. However, the warning level is still set on the NAS system.

9. Click **OK**.

Removing Disk Quota Entries

1. Log in to the NAS Manager.

See "[Logging in to the NAS Manager](#)."

2. Click **Disks**.
 3. Click **Disk Quota**.
 4. On the **Disk Quota** page, select the volume to manage.
 5. From the **Tasks** list, select **Quota Entries**.
 6. On the **Quota Entries** page, select the **Logon name** from which you want to remove the quota entry.
 7. On the **Tasks** list, select **Delete**.
 8. Click **OK**.
-

Using Logs

A log file stores messages, which are sometimes called events or event log entries, generated by an application, service, or operating system. The messages are used to track the operations performed by the system. Log files are usually plain text (ASCII) files and usually have the **.log** file extension.

The available logs are:

- Application log
- FTP log
- NFS log
- Security log
- System log
- Web (HTTP) shares log
- Web administration log

Viewing Log Entry Details

You can view details such as the date, time, source, event ID, description, and data of specific log files.

1. Log in to the NAS Manager.

See "[Logging in to the NAS Manager](#)."

2. Click **Maintenance**.
3. Click **Logs**.
4. On the **Logs** page, select the type of log you want to view.
5. Click the radio button next to the log entry you want to view.
6. In the **Tasks** list, click **Event Details** or **View Log** depending on the selected log type.
7. On the **Log Details** page, click **Up** and **Down** to scroll through the log files.
8. Click **Back** to close the **Log Details** page and return to the log entry list on the **Logs** page.

Modifying Log Properties

For system, security, and application logs, you can specify the maximum log size and determine how the system handles log entries when the maximum capacity of the NAS system is reached.

To modify the properties of a log file, perform the following steps:

1. Log in to the NAS Manager.

See "[Logging in to the NAS Manager.](#)"

2. Click **Maintenance**.
3. Click **Logs**.
4. On the **Logs** page, select the type of log you want to configure.
5. In the **Tasks** list, click **Log Properties**.
6. In the **Maximum log size** text box on the **Log Properties** page, enter the maximum size (in kilobytes) of the log.
7. Determine how you want the system to handle log file entries after the maximum log file size has been reached, and then click one of the following choices:
 - **Overwrite events as needed** — The system writes over older events with new events as they occur.
 - **Overwrite events older than ____ days** — The system retains the event entries for the specified number of days before the events can be written over by current event entries.
 - **Do not overwrite events** — The system retains all events in the log and appends new events to the end of the file.
8. Click **OK**.

Downloading Log Files

The **Download Log Files** page on the NAS Manager allows you to download specific log files from your NAS system.

1. Log in to the NAS Manager.

See "[Logging in to the NAS Manager.](#)"

2. Click **Maintenance**.
3. Click **Logs**.
4. On the **Logs** page, select the type of log you want to download.
5. In the **Tasks** list on the *Log Type Log* page, click **Download Log**.
6. On the **Download Log Type Log** page, if available, select the file type that you want to download, and then click **Download**.
7. In the **File Download** dialog window, select **Save this file to disk**.
8. Click **OK** to download the log file.

Viewing Downloaded Log Files

After downloading the log files, it is possible to view them in the following ways:

- **.log** files — With a text editor such as Microsoft Notepad.
- **.csv** files — With a text editor or with Microsoft Excel.
- **.evt** files — With the Event Viewer. The Event Viewer is usually under **Administrative Tools** on the **Start** menu of a Windows 2000 system. In the **Event Viewer** window, click **Action** and then click **Open Log File**. Browse to the location of your log file, choose the log type of your file, and then click **Open**.

Clearing Log Files

1. Log in to the NAS Manager.

See "[Logging in to the NAS Manager.](#)"

2. Click **Maintenance**.
 3. Click **Logs**.
 4. On the **Logs** page, select the type of log you want to clear.
 5. In the **Tasks** list, click **Clear**.
 6. On the **Delete Log File Confirmation** page, click **OK** to clear the log.
-

Shutting Down the NAS System

You can shut down the NAS system at any time by tapping the power button, or you can shut it down through the NAS Manager.

 **NOTE:** To shut down your system by pressing the power button, press but do not hold down the power button to get a normal shutdown. For an emergency shutdown, hold down the power button for approximately 5 seconds. An emergency shutdown causes any redundant dynamic volumes to regenerate when the system starts again. Regenerating dynamic volumes can take several hours to complete.

To shut down, shut down and restart, or schedule a shut down of the NAS system from the NAS Manager, perform the following steps:

1. Log in to the NAS Manager.

See "[Logging in to the NAS Manager.](#)"

2. Click **Maintenance**.
3. Click **Shutdown**.
4. Click **Shut Down, Restart**, or **Scheduled Shutdown**.
5. If you select **Scheduled Shutdown**, specify when the shutdown should occur, and then click **OK**.
6. On the **Confirmation** page, click **OK** to confirm the action.

If you selected to restart the NAS system, the **Restarting** page displays. When the NAS Manager detects that the NAS system has come back online, the NAS Manager automatically returns to the home page.

 **NOTE:** Do not refresh or perform any function in the NAS Manager until it comes back online. If you click **Refresh**, the NAS Manager might not refresh automatically.

Managing Disks

The NAS Manager allows you to list available disks, rescan for a disk, and view disk properties.

 **NOTE:** You cannot hot swap hard drives on the PowerVault 715N NAS system. You must turn off the system before removing or installing a hard drive. For information about removing and installing a hard drive, see "Installing Hard Drives" in the *Installation and Troubleshooting Guide*.

Listing Available Disks and Viewing Properties

1. Log in to the NAS Manager.

See "[Logging in to the NAS Manager.](#)"

2. Click **Disks**.

3. On the **Disks** page, click **Disks**.

The **Disks** page displays a list of the available disks and shows their status.

4. Click the disk whose properties you want to view, and then click **Properties**.

The **Properties** page displays the status, capacity, device type, and vendor for the selected disk.

Rescanning for Disks

1. Log in to the NAS Manager.

See "[Logging in to the NAS Manager](#)."

2. Click **Disks**.
3. In the **Physical Disks** column on the **Disks** page, select the disk to rescan.
4. In the **Tasks** list, click **Rescan**.
5. On the **Rescan** page, click **OK** to start the rescan.

Managing Volumes

A volume is an allocation of usable space on one or more physical disks. The NAS Manager allows you to reconfigure or repair a volume and view the properties of a volume.



NOTE: You can also create volumes in Array Manager. See "[Creating a Dynamic Volume](#)" in "Advanced Disk and Volume Management."

Creating a Volume

1. Log in to the NAS Manager.

See "[Logging in to the NAS Manager](#)."

2. Click **Disks**.
3. Click **Volumes**.
4. On the **Tasks** list, click **New**.

Reconfiguring a Volume



NOTICE: Reconfiguring a data volume deletes all data on the existing volume. Back up your data before reconfiguring a volume.

1. Prior to reconfiguring the volume, manually remove all shares and persistent images.



NOTE: If the volume is in use or contains shares or persistent images, the system does *not* complete the deletion and reconfiguration operation and displays the message `Use Array Manager`. The administrator can use Array Manager to force the deletion of the volume. See "[Using the Array Manager to Manage Your Disks and Volumes](#)" in "Advanced Disk and Volume Management."

2. If during the deletion, the system messages that it cannot complete the deletion, use Array Manager.

See "[Using the Array Manager to Manage Your Disks and Volumes](#)" in "Advanced Disk and Volume Management."

3. Log in to the NAS Manager.

See "[Logging in to the NAS Manager.](#)"

4. Click **Disks**.
5. Click **Volumes**.
6. In the **Volumes** column, select the volume whose properties you want to view.
7. On the **Tasks** list, click **Reconfigure**.

If **Repair** appears instead of **Reconfigure**, your volume is damaged and needs to be repaired. See "[Repairing a Volume.](#)"

8. Select the **New Layout**, which is either **Single RAID-5** or **Single RAID-0**.

 **NOTE:** RAID 0 volumes are not fault-tolerant and do not provide data protection if a drive fails.

9. Click **OK** to delete and reconfigure the volume.

 **NOTE:** If the volume is in use—for example, the volume is open in a browser window, the volume contains shares or snapshots, or another application is using the volume—a message displays stating that the operation has failed and that you need to use Dell OpenManage Array Manager. See "[Advanced Disk and Volume Management](#)" for more information.

Repairing a Volume

The operating system is loaded on a fault-tolerant RAID 1 mirrored volume, and data drives are originally configured as RAID 5 volumes. If an operating system drive or a data drive fails, use the NAS Manager to repair the volume to make it fault-tolerant again.

 **NOTE:** RAID 0 volumes are not fault-tolerant and cannot be repaired.

1. Shut down the NAS system.

See "[Shutting Down the NAS System.](#)"

2. Remove the failed hard drive.
3. Insert a new hard drive ordered from Dell that is the same size as or larger than the failed drive.

 **NOTE:** The repair feature will not work if you insert a hard drive that is smaller than the failed drive.

4. Power on the NAS system.
5. Log in to the NAS Manager.

See "[Logging in to the NAS Manager.](#)"

6. Click **Disks**.
7. Click **Volumes**.
8. Click **Repair**.

If the repair button does not appear, then you do not have a drive that is the same size as or larger than the failed drive, or you did not have the drive in the system when the system booted.

9. Click **OK**.

 **NOTE:** The process of fully rebuilding the RAID volumes may take several hours.

 **NOTE:** If the volume is in use—for example, the volume is open in a browser window, the volume contains shares or snapshots, or another application is using the volume—a message displays stating that the operation has failed and that you need to use Dell OpenManage Array Manager. See "[Advanced Disk and Volume Management](#)" for more information.

Viewing Volume Properties

1. Log in to the NAS Manager.

See "[Logging in to the NAS Manager.](#)"

2. Click **Disks**.
3. Click **Volumes**.
4. In the **Volumes** column, select the volume whose properties you want to view.
5. On the **Tasks** list, click **Properties**.
6. Click **OK** to return to the **Volumes** window.

Using the PowerVault Advanced Administration Menu

The Advanced Administration Menu is a software application that provides links to advanced functionality in your NAS system. The menu runs automatically when you access your NAS system through Terminal Services.

To access the Advanced Administration Menu, perform the following steps:

1. Log in to the NAS Manager.

See "[Logging in to the NAS Manager.](#)"

2. Click **Maintenance**.
3. Click **Terminal Services**, and then log in to the NAS system as an administrator.

 **NOTE:** The default administrative user name is `administrator` and the default password is `powervault`.

The Advanced Administration Menu displays. If it does not display, double-click the **Advanced Administration Menu** icon on the desktop of the NAS appliance.

4. Click **Administrative Tools** or **System Management** to display the list of selectable options.
5. Click the tool or setting you want.
6. When you are finished using the Advanced Administration Menu, log off by clicking **Logoff** at the bottom of the Advanced Administration Menu.

The following tools are available through the Advanced Administration Menu:

- **Broadcom Network Teaming** — Launches Broadcom Advanced Server Control Suite. This application is for the Broadcom NetXtreme Gigabit NIC, which is sold separately.
- **Computer Management** — Provides management for local or remote computers.
- **Disk Management** — Launches Dell OpenManage Array Manager, which provides a comprehensive storage management for your disks and volumes.
- **Distributed File System** — Allows management of multiple network shares.
- **Event Viewer** — Allows you to view events in your application log, security log, and system log.
- **Intel Network Teaming** — Launches Intel® PROSet II, which allows you to perform advanced functions on NICs,

such as setting up teaming and virtual LANs.

- **Internet Information Services** — Provides management for Internet Information Services on the system.
- **Local Security Settings** — Enables you to manually set security settings.
- **Network Properties** — Displays the **Network and Dial-up Connections** window.
- **Network Tools** — Displays the **Network Tools Interface Utility**, which allows you to perform operations such as nslookup, ping, and tracert.
- **Performance Monitor** — Displays the Performance Monitor.
- **Perform System State Backup** — Enables you back up your system-state data.
- **Retrieve Dell Service Tag** — Provides the Dell service tag number for your NAS system.
- **Set Date/Time** — Allows you to set the date and time.
- **Set Regional Options** — Displays the **Regional Options** window, which allows you to change the locale and language settings for the system.
- **Task Manager** — Provides applications, processes, and performance information.
- **Terminal Services Config** — Enables you to configure Terminal Services.
- **Windows Powered Help** — Displays help for Windows 2000.
- **Windows QFEs** — Displays the QFEs installed on the NAS system.
- **Windows 2000 Backup/Recovery** —Launches Windows 2000 Backup and Recovery Tools.

Click the **Language** link to change the language of the Advanced Administration Menu to Chinese, English, French, German, Japanese, or Spanish.

[Back to Contents Page](#)

Advanced Disk and Volume Management

Dell™ PowerVault™ 715N NAS Systems Administrator's Guide

- [How the Drives Are Configured](#)
- [Using the Array Manager to Manage Your Disks and Volumes](#)

This section provides information about the drives on your NAS system and how to use Dell OpenManage™ Array Manager to manage your disks and volumes and your physical hard drives.

How the Drives Are Configured

The NAS system, which is a rack-mounted system, has four IDE hard drives that are in a RAID configuration. Each drive contains both a copy of the operating system and one or more data partitions (see [Table 3-1](#)). The working copies of the Microsoft® Windows® Powered operating system and boot sectors are installed on two hard drives in partitions that are RAID 1 (mirrored) partitions. Additional copies of the operating system are placed on the other two drives in RAID 1 partitions. Data can be stored on all four drives in partitions that are configured as RAID 5.

Table 3-1. Hard Drive Partitions

Volume	Disks and RAID Layout	Description
C:	0 and 1: RAID 1	Primary operating system volume (3 GB)
D:	2 and 3: RAID 1	Recovery operating system volume (3 GB)
E:	0, 1, 2, and 3: RAID 5	Data volume (remaining space on all hard drives)

Using the Array Manager to Manage Your Disks and Volumes

Although Dell OpenManage Array Manager provides a comprehensive solution to storage management, you should use it for *advanced features* that cannot be performed from the **Disks** tab in the NAS Manager.

Array Manager allows you to configure your storage devices and the logical volumes contained in your system. Array Manager displays storage configuration in both a physical and a logical view. The physical view shows the physical connections between the storage devices. The logical view shows a logical representation of your storage as logical volumes.

Launching Array Manager From the NAS Manager

1. Log in to the NAS Manager.

See "[Logging in to the NAS Manager](#)" in "NAS Manager."

2. Click **Maintenance**.
3. Click **Terminal Services**.
4. Log in to the **Terminal Services** session as an administrator.

 **NOTE:** The NAS Manager default administrator user name is `administrator` and the default password is `powervault`.

5. From the Advanced Administration Menu, click **Disk Management** under **System Management**.

 **NOTE:** If the Advanced Administration Menu does not display, double-click the **Advanced Administration Menu** icon on the desktop of the NAS system.

6. If a Dell OpenManage Array Manager window with buttons such as **Create Volume** or **Create Virtual Disk**

displays, click the task you want to perform, or close the window to view the Array Manager Console.

Array Manager Console

The Array Manager console display uses a tree view to display storage objects in the left pane of the window and tabbed views in the right pane to display additional information about storage objects. The following subsections provide more information about the left and right panes.

Left Pane

The left pane shows objects that the Array Manager software detects. The major storage objects are the local system object, arrays, disks, and volumes. By clicking the plus sign (+) in front of a storage object, you can see the subordinate storage objects under that object.

- Disks represent the disks recognized by the Microsoft Windows Powered operating system.
- Volumes include dynamic RAID volumes created in Array Manager, primary and extended partitions, and logical drives associated with extended partitions.
- **My Network Places**, **History**, and **Favorites** provide remote connection functionality not supported by the PowerVault 715N system and should be ignored.

Right Pane

The right pane identifies the various objects and their status and displays any error conditions that might exist. The four tabbed views in the right pane include the following:

- The **General** tab displays parameters based on the objects you select in the console's tree view.

The parameters for **Disks** are as follows:

- **Name** is the name of the object.
- **Status** can vary, depending on the object. Common status conditions are **Online**, **Healthy**, and **Resynching**.
- **Type** identifies the object, such as **Dynamic Disk**.
- **Disk Group** shows an entry for disks in a basic or dynamic group.
- **Capacity** is the maximum size of the disk.
- **Unallocated Space** is the amount of free hard-drive space still available.
- **Graphical Layout** is a graphical representation of how much of the disk is being used.
- **Progress** shows the current progress (percentage of completion) for tasks.
- **Device** is the type of disk: All of the drives on the NAS system are IDE drives. However, two of the drives will appear in Array Manager as SCSI drives. This is a design issue that will be addressed in a later release.
- **Port** identifies the controller card. A SCSI port has zero or more target IDs, and a target ID has one or more logical unit numbers (LUNs).
- **LUN** is the logical unit number.
- **Target** is the SCSI ID that uniquely identifies the disk on the controller card.
- **Vendor** identifies the vendor on hardware objects.

The parameters for **Volumes** are as follows:

- **Name** is the name of the object.
- **Status** can vary, depending on the object. Common status conditions are **Online**, **Healthy**, and **Resynching**.

- **Layout** identifies the object, such as **Dynamic Mirrored Volume** and **Dynamic Striped Volume**.
 - **Disk Group** shows an entry for disks in a basic or dynamic group.
 - **Capacity** is the maximum size of the disk.
 - **Free Space** is the amount of free hard-drive space still available.
 - **Progress** shows the current progress (percentage of completion) for tasks.
 - **File System** shows the type of file system.
 - **Graphical Layout** is a graphical representation of how much of the disk is being used.
- The **Events** tab displays event log messages associated with storage objects.
 - The **Disk View** tab displays a graphical layout of the disks on your system, including CDs or other removable media.
 - The **DM View** tab is grayed-out on the Array Manager console.

Disk Management

This subsection provides conceptual and procedural information about how Array Manager implements basic and dynamic disks.

The following topics are discussed:

- Upgrading a basic disk to a dynamic disk
- Reactivating dynamic disks
- Merging foreign disks

Upgrading a Basic Disk to a Dynamic Disk

Basic and Dynamic Disks

Disks are any storage unit presented to Windows 2000 as a single contiguous block of storage. When using the Array Manager, you can use two types of disks—basic or dynamic.

Basic disks employ the traditional disk partitioning used by MS-DOS® and Microsoft Windows 95, Windows 98, and Windows NT® 4.0 operating systems. A basic disk can have up to four primary partitions or three primary partitions plus an extended partition. The extended partition can be subdivided into a number of logical drives.

Dynamic disks contain volume management databases comprising information about all other dynamic disks and volumes on a system. This information allows dynamic disks to support dynamic volumes, which are defined in the following subsection. Storage on a dynamic disk is divided into volumes instead of partitions.

Basic and Dynamic Volumes

A volume is made up of portions of one or more physical disks. You can format a volume with a file system and access it by a drive letter. Like disks, volumes can be basic or dynamic.

Basic volumes refer to volumes created on basic disks. They include primary and extended partitions and logical drives on extended partitions.

Dynamic volumes are volumes created on dynamic disks. There are five types of dynamic volumes—simple, spanned, mirrored, striped, and RAID-5. However, you can expand only simple and spanned volumes using Dell OpenManage Array Manager. These are the only types of volumes that this document addresses. See the Dell OpenManage Array Manager online help for more information about mirrored, striped, and RAID-5 dynamic volumes.

To upgrade a basic disk to a dynamic disk, perform the following steps:

1. Launch Array Manager.

See "[Launching Array Manager From the NAS Manager.](#)"

2. Right-click the disk you want to upgrade and click **Upgrade Dynamic Disk**.

The Upgrade Disk Wizard provides information about upgrading.

3. Click **Next** to continue.

The system asks you to select the disks to upgrade.

4. Add the basic disks you want to upgrade to the list of dynamic disks and click **Next**.
5. Click **Finish**.



NOTE: After a disk is upgraded to dynamic, it cannot be reverted back to basic unless all volumes on that disk are removed. Dell recommends that you do *not* revert a disk back to basic after data volumes are present.

Reactivating Dynamic Disks

A dynamic disk might appear as a missing disk when it is corrupted, powered down, or disconnected. You can reactivate a dynamic disk to bring it back online by performing the following steps:

1. Launch Array Manager.

See "[Launching Array Manager From the NAS Manager.](#)"

2. Right-click the disk labeled **Missing** or **Offline dynamic disk**.
3. Click **Reactivate Disk** on the menu.

The disk is labeled **Online** after it has been reactivated.

Merging Foreign Disks

Dynamic disks with a foreign status are disks that have been moved from another system. You cannot reactivate a foreign disk; you must merge the disk to the system. To change the status of a foreign disk and enable it to be seen as a part of the current system, use the **Merge Foreign Disk** command.

To merge foreign disks, perform the following steps:

1. Launch Array Manager.

See "[Launching Array Manager From the NAS Manager.](#)"

2. Right-click a disk marked as **Foreign** and click **Merge Foreign Disks**.

The Merge Foreign Disk Wizard displays.

3. Select the foreign disks that you want to merge to the system.

By default, the system selects all foreign disks to be merged.

4. Click **Next**.
5. Click **Next** again to validate the volume status of each foreign disk.
6. Click **Finish**.

Volume Management

This subsection provides conceptual and procedural information about how Array Manager implements basic and dynamic volumes.

The following topics are discussed:

- Volume overview
- Checking partition or volume properties
- Formatting a partition or volume
- Deleting a partition or volume

Volume Overview

A volume is a logical entity that is made up of portions of one or more physical disks. A volume can be formatted with a file system and can be accessed by a drive letter.

Like disks, volumes can be basic or dynamic. In Array Manager, basic volumes refer to all volumes that are not on dynamic disks. Dynamic volumes are logical volumes created from dynamic disks with Array Manager.

In your system, create all data volumes and dynamic volumes on dynamic disks.

Checking Partition or Volume Properties

1. Launch Array Manager.

See "[Launching Array Manager From the NAS Manager.](#)"

2. Right-click the partition or volume to be checked.
3. Select **Properties** from the context menu.

The **Properties** window displays.

4. Check the properties for your volume.

Formatting a Partition or Volume

1. Launch Array Manager.

See "[Launching Array Manager From the NAS Manager.](#)"

2. Right-click the volume or partition you want to format, and then click **Format**.
3. Select **NTFS** as the file system type.



NOTE: The PowerVault 715N supports only NTFS partitions. Formatting all partitions as NTFS allows for advanced features only available under that file system.

4. Enter a label for the volume.

The label appears on the Array Manager console. If a name has been selected, this name appears in the **Name** field. You can change the name by typing a different name.

5. Enter an allocation size or use the default, which is automatically selected.
6. Select the file system type and formatting options:

- **Quick format** — Formats the volume or partition without scanning for bad sectors in the volume or partition. Check the box to use this format method.
- **Enable file and folder compression** — This option is not supported on the NAS system.

7. Click **OK** to begin formatting.

A progress bar displays in the list view.

Delete a Partition or Volume

 **NOTICE:** You must delete all shares and persistent images from your volume before deleting it. If a volume is removed before all shares of that volume have been removed, the NAS Manager might not display shares correctly.

1. Launch Array Manager.

See "[Launching Array Manager From the NAS Manager.](#)"

2. Right-click the designated volume, and then click **Delete Volume**.
3. Click **Yes** to delete or **No** to cancel.

The system deletes the volume immediately if you click **Yes**.

Working With Dynamic Volumes

Dynamic volumes are volumes created on dynamic disks with Array Manager. This section discusses how to create and extend dynamic volumes.

Creating a Dynamic Volume

 **NOTE:** To take advantage of all the system features such as defrag and encryption, Dell recommends that you use the default value of 64 KB for the allocation unit size when creating a virtual disk.

1. Launch Array Manager.

See "[Launching Array Manager From the NAS Manager.](#)"

2. From the toolbar, click the **Create Volume** icon.

The Create Volume Wizard appears.

3. Click **Next**.

You must select whether to create a partition or a volume. Make sure that the **Dynamic Volume** button is selected.

The dynamic group to which the volume belongs is automatically created and appears selected.

4. Click **Next**.

You are prompted for the volume layout and size of the volume to create.

5. Click **Concatenated**, **Striped**, or **RAID-5**.
6. If you selected **Striped** or **RAID-5**, choose the **Number of Columns**.

The number of columns represents the number of disks to be used in the dynamic volume array.

7. Select **MB** (megabytes) or **GB** (gigabytes) and enter the size of the volume in **Total volume size** field, or use the **Query Max Size** button.

Query Max Size works differently, depending on whether you have one disk or multiple disks selected.

- If you do not select a disk and click **Query Max Size**, the size shown in the **Total volume size** field is the maximum for all available disks.
- If you select a disk or disks and click **Query Max Size**, the size indicated is the maximum size for the selected disk(s). However, if you click **Query Max Size** a second time, the size is the maximum for all

available disks.

8. Click **Next**.
9. After all selections are made, verify your settings and click **Next**.
10. If you want to select a different disk for the volume you are creating, click **Modify** to display the **Modify Disks** dialog box.
11. Click the disk you want to change, select a disk from the **Disk** drop-down menu, and then click **OK**.
12. Click **Assign a drive letter**, select the drive letter, and then click **Next**.
13. Make sure **Format this volume** and **NTFS** are selected.
14. Type a volume label and an allocation unit size, if you chose to use a size other than the default.
15. Click **Next**, and then click **Finish**.

Working With Mirrors

A mirrored volume is a volume that duplicates your data to two physical disks. A mirror provides redundancy by simultaneously writing the same data to two separate volumes that reside on different disks. If one of the disks fails, data continues to be written to and read from the unaffected disk.

This section discusses how to add, remove, or break a mirror.

Adding a Mirror

1. Launch Array Manager.

See "[Launching Array Manager From the NAS Manager](#)."

2. In the **Dell OpenManage Array Manager** window, click the **Volumes** folder to expand it.
3. In the left pane, right-click a volume name, and then click **Add Mirror**.

The Add Mirror Wizard displays.

4. Click **Next**.
5. Select **Custom Mode**, and then click **Next**.
6. Verify that the correct disk for mirroring the volume is selected. If the correct disk is not selected, click **Modify**, and then go to step 7. If the correct disk is selected, go to step 9.
7. From the **Modify Disk Selection** window, click the disk you want to change.

A drop-down box appears.

8. Click the arrow, select a different disk from the drop-down box, and then click **OK**.
9. Click **Next**, and then click **Finish** to create the mirror.

Removing a Mirror

Removing a mirror from a volume removes or destroys the data from the selected mirror and leaves the other mirror intact. After you remove a mirror, the space on the disk used by the removed mirrored volume becomes unallocated space. The remaining (no longer mirrored) volume becomes a simple volume on the disk.

To remove a mirror, perform the following steps:

1. Launch Array Manager.

See "[Launching Array Manager From the NAS Manager.](#)"

2. In the **Dell OpenManage Array Manager** window, click the **Volumes** folder to expand it.
3. In the left pane, right-click a volume name, and then click **Remove Mirror**.

The **Remove Mirror** window displays.

4. Select the mirror you want to remove, and then click **OK**.

Breaking a Mirror

Breaking a mirror creates two simple volumes with individual drive letters. Each volume contains the data on the mirror at the time the mirror was broken. The data is no longer redundant, but it remains intact.

To break a mirror, perform the following steps:

1. Launch Array Manager.

See "[Launching Array Manager From the NAS Manager.](#)"

2. In the **Dell OpenManage Array Manager** window, click the **Volumes** folder to expand it.
3. In the left pane, right-click a volume name, and then click **Break Mirror**.

The confirmation message, *Are you sure you want to break the mirror?* displays.

 **NOTICE:** If you break the mirror, your data might not be fault-tolerant.

4. If you are sure you want to break the mirror, click **OK**.

[Back to Contents Page](#)

Backing Up the System

Dell™ PowerVault™ 715N NAS Systems Administrator's Guide

- [System-State Backup](#)
- [Backing Up Data Volumes](#)
- [Backing Up Dell ActiveArchive™ Persistent Images](#)

This section provides instructions on how to back up files on your system. You should regularly backup, or have mirrors of, the following types of information:

- System state — Files that contain configuration information about the NAS system. System-state files include the registry, COM+ class registration database, system boot files, users and groups information, and CIFS/NFS/Novell® NetWare®/Macintosh share data.
- Operating system — Files that are necessary to run the Microsoft® Windows® Powered operating system on the NAS system.
- Data files — The documents and other files that are not part of the operating system.

System-State Backup

Backing up the system state allows you to recover the system if an operating system reinstallation is required. Restoring your system state restores customized settings such as user information and share information.

System-state data includes the following:

- Registry
- COM+ class registration database
- System boot files
- Users and groups information
- CIFS/NFS/Novell NetWare/Macintosh share data

For more information, refer to the online help for Windows 2000 Backup & Recovery Tools.

Backing Up System-State Data

Dell recommends that you regularly back up your system state. This action enables you to go back to the most recent state if an operating system reinstallation is required.

To back up system-state data, perform the following steps:

1. Log in to the NAS Manager as an administrator.

See "[Logging in to the NAS Manager](#)" in "NAS Manager."

2. Click **Maintenance**.
3. Click **Backup**.
4. In the **Log on to Windows** window, enter the administrator user name and password and click **OK**.

 **NOTE:** The default administrative user name is `administrator` and the default password is `powervault`.

The **Welcome to Windows 2000 Backup and Recovery Tools** window displays.

 **NOTE:** If the **Windows 2000 Backup and Recovery Tools** window does not display, click **Maintenance**, and then click **Terminal Services**. On the Advanced Administration Menu, click **Administrative Tools** and then click **Windows 2000 Backup/Recovery**.

5. Click **Backup Wizard**.
6. In the **Backup Wizard** window, click **Next**.
7. In the **What to Back Up** window, click **Only back up the System State data**, and then click **Next**.
8. In the **Where to Store the Backup** window, click **Browse**.
9. In the **Open** window, select the location to store your system-state backup file, enter the filename, and then click **Open**.

For fault tolerance, you should select a location that is not on the NAS system.

10. Click **Next** and then click **Finish**.

The backup begins and progress displays in the **Backup Progress** window.

11. When the backup is complete, click **Close**.

Restoring System-State Data

To restore your system-state data, you must have previously backed up your system using the backup and recovery tools. See "[Backing Up System-State Data](#)."

 **NOTE:** If you are restoring system-state data after reinstalling the operating system, perform the procedure in "[Restoring System-State Data After Reinstallation](#)" in "Recovering and Restoring the System."

To restore system-state data, perform the following steps:

1. Log in to the NAS Manager as an administrator.

See "[Logging in to the NAS Manager](#)" in "NAS Manager."

2. Click **Maintenance**.
3. Click **Backup**.
4. In the **Log on to Windows** window, enter the user name and password and click **OK**.

 **NOTE:** The default administrative user name is `administrator` and the default password is `powervault`.

The **Welcome to Windows 2000 Backup and Recovery Tools** window displays.

5. Click **Restore Wizard**.
6. In the **Restore Wizard** window, click **Next**.
7. In the **What to Restore** window, click **(+)** to expand the **File** tree, and then click to expand **Media created yyyy/mm/dd**, where `yyyy/mm/dd` is the year/month/date that you made the system-state backup.
8. Click the check box next to **System State**, and then click **Next**.
9. Click **Finish**.
10. When the **Enter Backup File Name** window displays, click **OK**.

 **NOTE:** If your backup file is in a different location, click **Browse** and locate the file.

11. Restart the system after the restore process completes.

 **NOTE:** Windows must replace all locked files on the system; therefore, the process of restarting the system might take approximately 15 minutes to complete.

Backing Up Data Volumes

To back up your volumes, you can use direct-attached local backups or network backups.

The following software is supported for direct-attached local backups:

- Windows 2000 Backup and Recovery Tools
- VERITAS® Backup Exec® Server Professional 8.5 and 8.6 for Windows NT® and Windows 2000

The following software is supported for remote network backups:

- VERITAS Backup Exec Server Professional 8.5 and 8.6 for Windows NT and Windows 2000
- Computer Associates® ARCserveIT™
 - ARCserveIT 2000 for Windows NT and Windows 2000
 - ARCserveIT 6.61 for Red Hat Linux 7.0
 - ARCserveIT 7.0 for Red Hat Linux 7.0 and 7.1

Windows 2000 Backup and Recovery Tools

Windows 2000 backup and recovery tools allow you to back up your data volumes to a locally attached tape drive or to a file.

 **NOTE:** You must have a supported SCSI card and a tape drive installed to back up your data volumes to tape.

You can access the Windows 2000 backup and recovery tools by clicking the **Maintenance** tab on the NAS Manager primary menu and clicking **Backup** or by clicking **Windows 2000 Backup/Recovery Tools** on the Advanced Administration Menu under **Administrative Tools**.

For more information about the Windows 2000 backup and recovery tools, see the Windows Powered Help. You can access Windows Powered Help by clicking **Windows Powered Help** in the Advanced Administration Menu under **Administrative Tools** or by clicking **Help** in the Start menu when using the Terminal Services Client.

Installing Tape Device Drivers for Windows 2000 Backup and Recovery Tools

If you are using Windows 2000 backup and recovery tools, you might need to install drivers for both tape drives and tape media changers.

 **NOTE:** Most of the tape device drivers are located in the `c:\dell\drivers` directory. However, you should always check the Dell | Support website at support.dell.com for updated drivers and patches.

Installing Drivers for Dell™ PowerVault™ Tape Drives

1. Connect the PowerVault tape drive, and then restart the system.
2. Log in to the NAS Manager.

See "[Logging in to the NAS Manager](#)" in "NAS Manager."

3. Click **Maintenance**.
4. Click **Terminal Services**.
5. Log in to a Terminal Services Client session.

6. On the Advanced Administration Menu under **System Management**, click **Computer Management**.

 **NOTE:** If the Advanced Administration Menu does not display, double-click the **Advanced Administration Menu** icon on the desktop of the NAS system.

7. Click **Computer Management** in the left pane.
8. Click **System Tools** in the left pane.
9. Click **Device Manager** in the left pane.
10. Click **Unknown Devices** in the right pane.

 **NOTE:** The tape device may also appear under **Other Devices**.

11. Double-click the tape device.
12. Click **Driver** in the pop-up window.
13. Click **Update Driver**.

The Upgrade Device Driver Wizard displays.

14. Click **Next**.
15. Click the radio button next to **Search for a suitable driver for my device (recommended)**, and then click **Next**.
16. In **Optional search locations**, click the check box next to **Specify a location**, and deselect the other check boxes.
17. Click **Next**.
18. In the path for **Copy manufacturer's files from**, specify the folder name that contains the device drivers.
19. Click **OK**, and then click **Next**.

The Upgrade Device Driver Wizard searches the specified folder for the driver files.

20. Make sure that the wizard has selected the appropriate PowerVault tape device, and then click **Next**.
21. Click **Finish**.
22. Click **Close** to exit the driver properties dialog box.

Installing Drivers for PowerVault Tape Drive Media Changers

To install drivers for tape media changers when using Windows 2000 backup and recovery tools, perform the following steps:

1. Connect the PowerVault tape device, and then restart the NAS system.
2. Log in to the NAS Manager.

See "[Logging in to the NAS Manager](#)" in "NAS Manager."

3. Click **Maintenance**.
4. Click **Terminal Services**.
5. Log in to a **Terminal Services Client** session.
6. In the Advanced Administration Menu, click **Computer Management** under **System Management**.

 **NOTE:** If the Advanced Administration Menu does not display, double-click the **Advanced Administration Menu** icon on the desktop of the NAS system.

7. Click **Computer Management** in the left pane, and then click **System Tools**.
8. Click **Device Manager** in the left pane.
9. Click **Medium Changers** in the right pane.
10. Double-click **Unknown Medium Changer**.
11. Click **Driver** in the **Properties** window.
12. Click **Update Driver**.

The Upgrade Device Driver Wizard displays.

13. Click **Next**.
14. Click the radio button next to **Search for a suitable driver for my device (recommended)**, and then click **Next**.
15. In **Optional search locations**, click the check box next to **Specify a location**, and deselect the other check box.
16. Click **Next**.

A dialog box displays with a field for you to enter the location of the device driver.

17. In the path for **Copy manufacturer's files from**, specify the folder name that contains the device drivers, and then click **OK**.
18. Click **Next**.

The Upgrade Device Driver Wizard searches the specified folder for the driver files.

19. Make sure that the Upgrade Device Driver Wizard has selected the appropriate PowerVault tape device, and then click **Next**.
20. Click **Finish**.
21. Click **Close**.

VERITAS Backup Exec

 **NOTE:** Before installing the backup software, check the Dell | Support website at support.dell.com for the latest driver and software updates. You might need to install the updates after completing the procedures below.

Installing VERITAS Backup Exec on the NAS System

 **NOTE:** VERITAS Backup Exec supports installation using Terminal Services and management using VERITAS Remote Administrator.

1. Share the CD drive on a remote system, mount that remote CD drive on the NAS system, and then insert the *VERITAS Backup Exec* CD in the CD drive of the remote system.
2. Log in to the NAS Manager.

See "[Logging in to the NAS Manager](#)" in "NAS Manager."

3. Click **Maintenance**.
4. Click **Terminal Services**.
5. Log in to the NAS system.

6. Map a network drive to the CD share, but *do not* select **Reconnect at logon**.
7. Follow the instructions in the documentation that came with your backup software.



NOTE: After the software installation is complete, disconnect the network drive for the CD share before you reboot your system. To disconnect the network drive, right-click **My Appliance** on the NAS system desktop, and select **Disconnect Network Drive**. Click the CD share in the **Disconnect Network Drive** window, and then click **OK**.

Installing VERITAS Backup Exec Remote Administrator on a Client System

1. Insert the *VERITAS Backup Exec* CD in the CD drive of the client system.

The CD starts the software automatically.

2. If the CD does not start the software automatically, open Windows Explorer, right-click the CD drive that contains the VERITAS software, and select **Autoplay** from the menu.
3. Follow the instructions in the documentation that came with your backup software.

Using VERITAS Backup Exec Remote Administrator

1. On the remote system, click the **Start** button, and then point to **Programs® VERITAS Backup Exec® VERITAS Backup Exec**.

The **Connect to Server** window displays.

2. Enter the name of the NAS system in the **Server** field.
3. Enter login information in the **Login Information** field, and then click **OK**.

The **Backup Exec Assistant** window, which displays in front of the **Backup Exec** window, provides wizards for many common backup tasks. You can also use the **Tools** menu on the **Backup Exec** window to display the **Backup Exec Assistant**.

Use Remote Administrator to manage all backup operations just as you would from the local application. See the VERITAS Backup Exec documentation for more information about how to use the software.

Backup Software for Network Backups

You may back up your data volumes over the network to local area network (LAN)-attached backup servers. This backup requires that you already have a backup server on your network.

Dell recommends that you use backup software network accelerator agents to greatly improve network backup performance.

Installing Network Accelerator Agents

VERITAS Backup Exec accelerator agents can be installed remotely by installing the agent to the system from a remote system on the network.

See the documentation for your backup software for more information about how to install the network accelerator agents.

Backing Up Dell ActiveArchive™ Persistent Images

Backing up persistent images eliminates the possibility of files changing during the back up job. Persistent images always contain the data that existed when the persistent image was taken. However, backing up persistent images requires that you perform several steps and should be performed only by advanced backup administrators. Dell recommends that you use the available open file agents in VERITAS Backup Exec to back up your open files rather than backing up persistent images.

 **NOTE:** Do not use Computer Associates ARCserve to back up persistent images.

To back up a persistent image, perform the following steps:

1. Use the NAS Manager to create a persistent image.

See "[Dell ActiveArchive](#)."

 **NOTE:** For increased performance, back up only read-only persistent images.

2. On the NAS Manager primary menu, click **Maintenance**.
3. Click **Terminal Services** and log in to the NAS system.
4. When the **PowerVault Advanced Administration** window displays, click **Exit**.
5. Double-click **My Appliance** and browse to the persistent image you created in step 1.

Persistent images are located in the Dell ActiveArchive directory of the volume on which you created the persistent image in step 1.

6. Right-click the persistent image, and then click **Sharing**.
7. Click **Share this folder**.
8. Type the name of the share in the **Share name** field.
9. Click **Permissions**.
10. Set the required permissions in the **Permissions** window, and then click **OK**.
11. Click **OK** in the **Properties** window.
12. On the system that is running VERITAS Backup Exec, set up VERITAS Backup Exec so that it is able to back up user shares.

You can find this option in **Tools® Options** menu on the **Network** tab.

13. In the VERITAS Backup Exec **Backup Selections** window, browse to your NAS system under **Entire Network**.
14. Select the share name that you created in step 8 for your persistent image.
15. Deselect the **Persistent Storage Manager State** directory when performing persistent image backups.

This directory contains files needed for persistent images. However, to save space on your backup media, backing up the files is not recommended.

16. Click **Backup**.
17. Select **Run Now** to run the backup now or **Schedule** to schedule your backup job to run at a later time.

 **NOTE:** Although you are backing up your persistent image from a network share, it does not create network traffic if you are backing up to a local backup device.

Limitations on Backing Up Persistent Images

- You cannot do incremental or differential backups of persistent images.
- You cannot use GFS rotation schemes when backing up persistent images.
- You cannot schedule a backup of a persistent image.

You must perform a manual backup of persistent image files because each persistent image filename is unique in that it includes the date and time (hour-minute-second) that the persistent image was taken.

- When you restore a persistent image, you must redirect the restore to a location other than the original persistent

image location. A restore to the original location is not successful.

Restoring Persistent Images From Tape Backup

 **NOTE:** Do not use Computer Associates ARCserve to restore persistent images.

To restore your persistent images from tape backup, perform the following steps:

1. On the system on your network that is running VERITAS Backup Exec, click the **Restore Selections** tab to bring up the window that lists your previous backup files.
2. Browse to your backup of the persistent image that you want to restore, and then select it by clicking the check box next to it.
3. Click **Restore**.
4. Click the **Redirection** tab.
5. Click the check box next to **Redirect Files**.
6. Enter the drive letter and path where you want the files to be restored.
7. Click **Run Now** to run the restore immediately or click **Schedule** to schedule your restore job to run at a later time.

[Back to Contents Page](#)

Recovering and Restoring the System

Dell™ PowerVault™ 715N NAS Systems Administrator's Guide

- [Solutions to Try Before Reinstalling](#)
- [Hard-Drive Failures](#)
- [Software Failures](#)
- [Replacing Hard Drives](#)
- [Recovering From an Operating System Failure](#)
- [Restoring System-State Data After Reinstallation](#)
- [Restoring Initial System Setup](#)

This section provides instructions on how to recover the NAS system if the operating system or a hard drive fails. Additionally, this section provides information for possible solutions that do not require restoring the operating system or hard drives.

Because your NAS system is designed to have redundancy, it can recover from certain hardware and software failures. In some situations, it can recover automatically, and in others, you must have administrator privileges and manually intervene to recover the NAS system.

Use the following methods in the order listed to restore your NAS system:

1. Check all of the items in "[Solutions to Try Before Reinstalling](#)."
2. Swap the operating system hard drives as described in "[Booting From the Recovery Operating System Mirror Hard Drives](#)."
3. Reinstall the operating system as described in "[Recovering From an Operating System Failure](#)."

Solutions to Try Before Reinstalling

This section provides checks and solutions that you should try before you reinstall your operating system or replace a hard drive. Some of the checks require you to observe the LEDs on the front and back of the NAS system. For more information about the LEDs, see your *Installation and Troubleshooting Guide*.

- Does the power LED show that the NAS system is turned on? If not, is the power cable connected to the NAS system and a power source?
- Are the link LEDs on the NAS system and any network switches to which it may be connected illuminated?
- Are you using a standard Ethernet cable to connect to the network? Do not use the cable labeled "Ethernet Crossover Cable" that was shipped with your system.
- Have you allowed enough time for the NAS system to boot? The NAS system typically takes at least 5 minutes to boot.
- Does the NAS system boot completely? Use console redirection to connect to the NAS system and observe the boot process. See "[Console Redirection](#)" in "Troubleshooting."
- Can you connect using a serial connection? See the serial connection procedures in "[Configuring the NAS System for the First Time](#)" in "Initial Setup." If you can connect, then there may be a problem with your network.
- Are the LEDs for all four hard drives on the NAS system lit? If they are not all lit, you have a failed hard drive. See "[Hard-Drive Failures](#)."

Hard-Drive Failures

Your NAS system has a mirror of the operating system on hard drives, which allows you to recover in most cases. Depending on which drive fails, use one of the procedures in [Table 5-1](#) to recover from a hard-drive failure.

Table 5-1. Hard-Drive Recovery Procedures

Hard Drive That Failed	System Automatically Boots From Hard Drive	Necessary Action
Hard drive 0	1	Replace the failed hard drive. See " Replacing Hard Drive 0. "
Hard drive 1	0	Replace the failed hard drive. See " Replacing Hard Drive 1, 2, or 3. "
Hard drive 2 or 3	0 and 1	Replace the failed hard drive. See " Replacing Hard Drive 1, 2, or 3. "
More than two hard drives fail	NA	Reinstall new hard drives and the operating system. To replace the failed hard drives and reinstall the operating system, follow the procedures in " Replacing Hard Drives " and " Recovering From an Operating System Failure. "

Software Failures

To recover from the following software failures, use one of the following procedures:

- If the main operating system files are missing or corrupt, you must manually boot from the recovery operating system mirror hard drives 2 and 3. For instructions, see "[Booting From the Recovery Operating System Mirror Hard Drives.](#)" After the system is running, you can boot the system back to the main operating system hard drives and then perform a system-state restore operation. See "[Restoring System-State Data After Reinstallation.](#)"
- If the main operating system mirrored partition fails, you must manually boot from the recovery operating system mirror hard drives 2 and 3 and restore the original files to the main operating system hard drives 0 and 1. See "[Replacing Hard Drive 0.](#)" After the system is running, you can boot the system back to the main operating system hard drives and then perform a system-state restore operation. See "[Restoring System-State Data After Reinstallation.](#)"

Replacing Hard Drives

This section provides the procedures for replacing hard drive 0, hard drives 1, 2, or 3, re-establishing the recovery operating system partitions, and booting from the recovery operating system mirror hard drives.

Replacing Hard Drive 0

1. Shut down the NAS system.

See "[Shutting Down the NAS System](#)" in "NAS Manager."

2. Remove the front bezel from the NAS system.
3. Remove failed hard drive 0 from the NAS system.

See your *Installation and Troubleshooting Guide* for information about removing and replacing drives.

4. Remove good hard drive 1, and then insert it in the hard drive 0 location.
5. Insert a new hard drive in the hard drive 1 location.
6. Replace the front bezel on the NAS system.
7. Boot the NAS system.



NOTE: The NAS system takes approximately 5 minutes to boot completely.

8. Log in to the NAS Manager.

See "[Logging in to the NAS Manager](#)" in "NAS Manager."

9. Click **Disks**, and then click **Volumes**.
10. Click **Repair**.

 **NOTE:** If the repair button does not appear, then you do not have a drive that the same size or larger than the failed drive, you did not have the drive in the system when the system booted, or you were not using a RAID 5 volume. Use Array Manager to repair or reconfigure your volumes. See "[Using the Array Manager to Manage Your Disks and Volumes](#)" in "Advanced Disk and Volume Management."

Replacing Hard Drive 1, 2, or 3

1. Shut down the NAS system.

See "[Shutting Down the NAS System](#)" in "NAS Manager."

2. Remove the front bezel from the NAS system.
3. Remove the failed hard drive from the NAS system.

See your *Installation and Troubleshooting Guide* for information about removing and replacing drives.

4. Insert a new hard drive in the same location.
5. Replace the front bezel on the NAS system.
6. Boot your system.

 **NOTE:** The NAS system takes approximately 5 minutes to boot completely.

7. Log in to the NAS Manager.

See "[Logging in to the NAS Manager](#)" in "NAS Manager."

8. Click **Disks**, and then click **Volumes**.
9. Click **Repair**.

 **NOTE:** If the repair button does not appear, then you do not have a drive that the same size or larger than the failed drive, you did not have the drive in the system when the system booted, or you were not using a RAID 5 volume. Use Array Manager to repair or reconfigure your volumes. See "[Using the Array Manager to Manage Your Disks and Volumes](#)" in "Advanced Disk and Volume Management."

Recovering From an Operating System Failure

If the operating system for your NAS system fails, use one of the following methods to recover:

- Recover data by booting from the recovery mirror hard drives (recommended)
- Reinstall the operating system using a dedicated Microsoft® Windows® 2000 client system
- Reinstall the operating system using a Windows 2000 system that is on the same LAN
 - With a DHCP server
 - Without a DHCP server
- Use an existing Preboot Execution Environment (PXE) server

 **NOTICE:** This procedure resets your NAS system to the Dell™ default settings and deletes all data on the NAS system. Before performing this procedure, attempt to boot from the operating system image on the mirrored hard drives. See "[Booting From the Recovery Operating System Mirror Hard Drives.](#)"

Booting From the Recovery Operating System Mirror Hard Drives

You might need the NAS system to boot from the recovery operating system mirror so that you can perform a file restore on the main operating system mirror or access the data on the data partition and back it up to tape.

 **NOTE:** The recovery operating system mirror is intended as a temporary way to back up your data. After performing the backup, you should reinstall the operating system using the procedures in "[Reinstalling the Operating System.](#)"

To boot from the recovery drive, perform the following steps:

1. Shut down the NAS system.

See "[Shutting Down the NAS System](#)" in "NAS Manager."

2. Remove the front bezel from the NAS system.
3. Swap hard drives 0 and 2 with each other.

See your *Installation and Troubleshooting Guide* for information about swapping drives.

4. Swap hard drives 1 and 3 with each other.
5. Replace the bezel.
6. Turn on the NAS system.

The NAS system boots from the operating system on hard drives 0 and 1.

 **NOTE:** Because the system boots using the recovery image operating system with the Dell default settings, any configuration information is lost. See "[Configuring the NAS System for the First Time](#)" in "Initial Configuration."

7. Log in to the NAS Manager.

See "[Logging in to the NAS Manager](#)" in "NAS Manager."

8. Back up your data and then reinstall the operating system.

Reinstalling the Operating System

This procedure resets your NAS system to the Dell default settings and deletes all data on the NAS system. Before performing this procedure, attempt to boot from the operating system image on the mirrored hard drives and backup your data. See "[Booting From the Recovery Operating System Mirror Hard Drives.](#)"

Depending on your environment, you can use one of the following methods to reinstall the operating system:

- Use a dedicated Windows 2000 system (recommended)
- Use a Windows 2000 system on the network
- Use an existing PXE server

Using a Dedicated Windows 2000 System

 **NOTICE:** This procedure resets your NAS system to the Dell default settings and deletes all data on the NAS system. Before performing this procedure, attempt to boot from the operating system image on the mirrored hard drives. See "[Booting From the Recovery Operating System Mirror Hard Drives.](#)"

Requirements

- Crossover cable included with your NAS system
- Serial cable included with your NAS system
- Windows 2000 (Professional or Server Family) client system with a CD drive
- *Resource* CD included with your NAS system
- *Reinstallation* CD included with your NAS system

Procedure

To restore your NAS system to the Dell default settings, perform the following steps:

 **NOTICE:** This procedure deletes all of the data on your NAS system.

1. Connect a Windows 2000 client system to the NAS system.
 - a. Shut down the NAS system, and do not turn it back on until instructed.

See "[Shutting Down the NAS System](#)" in "NAS Manager."
 - b. Turn off the client system, if it is running.
 - c. Connect the crossover cable (labeled "Cross Over Ethernet Cable") to the Ethernet port labeled "LAN 1" on the NAS system and the Ethernet port on the client system.
 - d. Connect the serial cable between the COM port on the NAS system and the COM port on the Windows 2000 client system.

The COM port is the communication port on the client system to which you connected the serial cable in step 1. The COM port used on your client system is typically labeled COM1 or COM2.

2. Turn on the Windows 2000 client system.
3. Log in to the client system with an account that has administrator privileges.
4. Create a new user with the name `pv715` and the password set to `password`:
 - a. From the desktop of your client system, right-click **My Computer**, and then select **Manage**.
 - b. On the left side of the **Computer Management** window, double-click **Local Users and Groups**.
 - c. Right-click **Users** and select **New User**.
 - d. In the **New User** window, type `pv715` as the user name.
 - e. Type `password` for the password, and type it again in the **Confirm password** field.
 - f. Clear the **User must change password at next logon** check box.
 - g. Click **Create** and then click **Close**.
5. Change the name of the Windows 2000 client system to `pv715rec`:
 - a. From the desktop of your client system, right-click **My Computer**, and then select **Properties**.
 - b. In the **System Properties** window, click **Network Identification**.
 - c. Click **Properties**.
 - d. In the **Identification Changes** window, type `pv715rec` for the computer name.
 - e. Click **OK**, but do not reboot when prompted.
 - f. Click **OK** to close the **Properties** window.

6. Change the IP address on the network adapter of the client system to 10.40.10.1 and the Net mask to 255.255.255.0:
 - a. From the desktop of the client system, right-click **My Network Places** and select **Properties**.
 - b. In the **Network and Dial-up Connections** window, right-click the network interface controller that you connected to the NAS system with the crossover cable in step 1.
 - c. In the **Local Area Connection Properties** window, click **Internet Protocol (TCP/IP)**, and then click **Properties**.
 - d. Click **Use the following IP address**.
 - e. For IP address, type 10.40.10.1.
 - f. For Subnet mask, type 255.255.255.0.
 - g. Click **OK**, and then click **OK** to close the **Local Area Connection Properties** window.
 - h. If you are prompted to reboot the client system, click **No**.

7. Create a share for the CD drive:

- a. Log in to the client system with an account that has administrator privileges.
- b. Double-click **My Computer**
- c. Right-click the CD drive, and select **Sharing**.
- d. Click **Share this folder**.
- e. Type CD for the name of the share, and then click **OK** to confirm the share settings.

8. Install the Dell Reinstallation Console from the *Resource* CD:

- a. Insert the *Resource* CD into the CD drive of your client system.

The **Dell PowerVault 715N Resource CD** window displays in a browser window.



NOTE: If the CD does not run automatically, double-click the **start.bat** file on the CD.

- b. Click **Resources**.
- c. Click **Install Reinstallation Console**.
- d. When the **File Download** window displays, click **Open this file from its current location**, and then click **OK**.
- e. Click **Next** and follow the instructions on the screen.
- f. When prompted to reboot the client system, click **Yes**.

The *Resource* CD is no longer required; remove it from the client system.

9. Insert the *Reinstallation* CD in the client system's CD drive.

10. Enable the Dell OpenManage™ Kick-Start utility and create your DHCP settings:

- a. Turn on the NAS system.

The system must be turned on so that you can set the IP address with Kick-Start.

- b. Click the **Start** button and point to **Programs® Dell Reinstallation Console® Dell OpenManage KickStart**.
- c. When asked if you want to run the program, click **Yes**.
- d. At the bottom of the **Dell OpenManage Kick-Start** window, click **Setup**.
- e. Click **Add**.

- f. In the **Add Scope** window, enter the following information and click **OK**:
 - o 10.40.10.10 for **Starting IP Address**
 - o 10.40.10.20 for **Ending IP Address**
 - o 255.255.255.0 for **Subnet**
 - o 10.40.10.1 for **Gateway IP Address**
- g. Click **OK** to close the **Add Scope** window.
- h. Click **Interfaces for DHCP Server** so that it is checked.
- i. Click **OK** to close the **Setup** window.
- j. Click **Enabled** at the bottom of the **Dell OpenManage Kick-Start** window to start the integrated DHCP server.

11. Start the Intel PXE Server and verify that the services are running:

- a. Click the **Start** button and point to **Programs® Dell Reinstallation Console® Intel PXE Server**.
- b. In the **PXE Configuration Utility** window, right-click the server name, **PV715REC**, and then select **Start/Stop Services**.
- c. Verify that the proxy DHCP/Boot PXE and M/TFTP services are installed and running correctly by selecting **Stop** and then selecting **Start**.

If the services are running, the indicator should display *Started* after you click **Start** and *Stopped* after you click **Stop**.

- d. Click **OK**.

12. On the client system, create a HyperTerminal connection.

- a. Click the **Start** button and point to **Programs® Accessories® Communications® HyperTerminal**.
- b. If the **Location Information** window displays, complete the information for your area and click **OK**.
- c. In the **Connection Description** window, enter any name for the connection, and then click **OK**.
- d. In the **Connect To** window, use the **Connect using** drop-down menu to select the correct local COM port.

The COM port is the communication port on the client system to which you connected the serial cable in step 1. The COM port used on your client system is typically labeled COM1 or COM2.

- e. Click **OK**.
- f. In the **COMx Properties** window, set bits per second to **115,200** baud and flow control to **Xon/Xoff**. Leave the **Data bits**, **Parity**, and **Stop bits** options set to the defaults.
- g. Click **OK**.

13. Reboot the NAS system by pressing the power button for less than 2 seconds.

14. In the **HyperTerminal** window, press <F2> immediately after you see the following message:

Press <F2> to enter the Function Select menu.



NOTE: If you use a version of Microsoft Windows 2000 operating system earlier than Service Pack 2, the function keys do not work. You must press <Esc><2>.

15. From the menu, select option 3, **Reinstallation**, and then type *y* to confirm the selection.

16. When the screen warns that you are going to reinstall and that it will erase data, type *y*.

17. Press *y* again to confirm the selection.

Depending on your configuration, this process could take several hours to complete. When the reinstallation is complete, the NAS system shuts down.

 **NOTE:** During the reinstallation, do not attempt to connect to your NAS system.

18. After the NAS system shuts down, reboot the system.

The system is set to the original defaults.

19. Reconfigure the system.

See "[Configuring the NAS System for the First Time](#)" in "Initial Configuration."

Using a Windows 2000 Client System on the Same Network

With a Windows 2000 client system that is in the same network as the NAS system, you can install the NAS system operating system whether the network has a dynamic host control protocol (DHCP) server or not.

 **NOTE:** This procedure resets your NAS system to the Dell default settings. Before performing this procedure, attempt to boot from the operating system image on the mirrored hard drives. See "[Booting From the Recovery Operating System Mirror Hard Drives](#)."

Network Without a DHCP Server

If your network does not have a DHCP server, you need the following to reinstall the operating system:

- Serial cable included with your NAS system
- Windows 2000 (Professional or Server Family) client system with a CD and diskette drive on the same subnet as the NAS system
- *Resource* CD included with your NAS system
- *Reinstallation* CD included with your NAS system
- A range of available IP addresses

To reinstall your NAS operating system, perform the following steps:

 **NOTICE:** This procedure deletes all of the data on your NAS system.

1. Shut down the NAS system, and do not turn it back on until instructed.

See "[Shutting Down the NAS System](#)" in "NAS Manager."

2. Turn off the client system, if it is running.
3. Connect the serial cable between the COM port on the NAS system and the COM port on the Windows 2000 client system.

The COM port is the communication port on the client system to which you connected the serial cable in step 1. The COM port used on your client system is typically labeled COM1 or COM2.

4. Turn on the Windows 2000 client system.
5. Log in to the client system with an account that has administrator privileges.
6. Create a new user with the name `pv715` and the password set to `password`:
 - a. From the desktop of your client system, right-click **My Computer**, and then select **Manage**.
 - b. On the left side of the **Computer Management** window, double-click **Local Users and Groups**.

- c. Right-click **Users** and select **New User**.
 - d. In the **New User** window, type `pv715` as the user name.
 - e. Type `password` for the **Password**, and type it again in **Confirm password**.
 - f. Click **User must change password at next logon** to clear the check box.
 - g. Click **Create** and then click **Close**.
7. Create a share for the CD drive on the client system:
- a. Double-click **My Computer**.
 - b. Right-click the CD drive, and select **Sharing**.
 - c. Type `CD` for the name of the share, and then click **OK** to confirm the share settings.

8. Install the Dell Reinstallation Console from the *Resource* CD:

- a. Insert the *Resource* CD into the CD drive of your client system.

The **Dell PowerVault 715N Resource CD** screen displays in a browser window.



NOTE: If the CD does not run automatically, double-click the **start.bat** file on the CD.

- b. Click **Resources**.
- c. Click **Install Reinstallation Console**.
- d. When the **File Download** window displays, click **Open this file from its current location**, and then click **OK**.
- e. Click **Next** and follow the instructions on the screen.
- f. When prompted to reboot the client system, click **Yes**.

9. Create a reinstallation diskette from the *Resource* CD:

- a. Make sure that the *Resource* CD is in the CD drive of your client system.
- b. In the *Resource* CD **Main Menu** window, click **Resources**.
- c. In the **Resources** window, click **Reinstallation Diskette**.
- d. When the **File Download** window displays, click **Run this program from its current location**, and then click **OK**.
- e. Click **Yes** if you receive a security warning.

A DOS screen appears and prompts you to insert a diskette into the diskette drive of the client system.

- f. Insert a formatted diskette into the diskette drive of your client system, and then press <Enter>.

The DOS screen closes after the reinstallation diskette is made.

10. Edit the **go.bat** file for the renamed client system and CD drive:

- a. In Windows Explorer, right-click the **go.bat** file on the diskette, and then select **Edit** to edit the file to the following variable value for your environment:

`\\server_name\share_name`, where *server_name* is the name of the client system and *share_name* is the name of the CD drive share (for example, `\\PV715\CD`)

- b. Save and exit the **go.bat** file.

11. Update the boot image:

- a. If it is not still in the diskette drive, insert the reinstallation diskette that you created in step 9 into the diskette drive of the networked Windows 2000 client system.
- b. Click the **Start** button and point to **Programs® Dell Reinstallation Console® Update boot image**.
- c. Remove the diskette from the diskette drive and the CD from the CD drive.
- d. Reboot the client system.

12. If the *Resource CD* is still in the CD drive, remove it.

13. Insert the *Reinstallation CD* in the CD drive.

14. Enable the Dell OpenManage Kick-Start utility and create your DHCP settings:

- a. Click the **Start** button and point to **Programs® Dell Reinstallation Console® Dell OpenManage KickStart**.
- b. When asked if you want to run the program, click **Yes**.
- c. At the bottom of the **Dell OpenManage Kick-Start** window, click **Setup**.
- d. Click **Add**.
- e. In the **Add Scope** window, enter the IP network and subnet mask information.

If you are not sure about what to enter in these fields contact your network administrator.



NOTE: If you run Kick-Start in a non-DHCP environment, the you must enter a gateway IP address.

- f. Click **OK**.
- g. Click **Interfaces for DHCP Server** so that it is checked.
- h. Click **OK**.
- i. Click **Enabled** at the bottom of the **Dell OpenManage Kick-Start** window to start the integrated DHCP server.

15. Start the Intel PXE server and verify that the services are running:

- a. Click the **Start** button and point to **Programs® Dell Reinstallation Console® Intel PXE Service**.
- b. In the **PXE Configuration Utility** window, right-click the server name, **PV715REC**, and then select **Start/Stop Services**.
- c. Verify that the proxy DHCP/Boot PXE and M/TFTP services are installed and running correctly by selecting **Stop** and then selecting **Start**.

If the services are running, the indicator should display *Started* after you click **Start** and *Stopped* after you click **Stop**.

- d. Click **OK**.

16. On the client system, create a HyperTerminal connection:

- a. Click the **Start** button and point to **Programs® Accessories® Communications® HyperTerminal**.
- b. In the **Connection Description** window, enter any name for the connection, and then click **OK**.
- c. In the **Connect To** window, use the **Connect using** drop-down menu to select the correct local COM port.

This is the port to which your serial cable is connected.

- d. Click **OK**.
- e. In the **COMx Properties** window, set bits per second to **115,200** baud and flow control to **Xon/Xoff**.

f. Click **OK**.

17. Turn on your NAS system.

18. In the **HyperTerminal** window, press <F2> immediately after you see the following message:

Press <F2> to enter the Function Select menu.

 **NOTE:** If you use a version of Microsoft Windows 2000 operating system earlier than Service Pack 2, the function keys do not work. You must press <Esc><2>.

19. From the menu, select option 3, **Reinstallation**, and then type *y* to confirm the selection.

The NAS system automatically reboots and begins the reinstallation process, which restores the NAS system back to the Dell default settings.

20. When the screen warns that you are going to reinstall and that it will erase data, type *y*.

21. Press *y* again to confirm the selection.

Depending on your configuration, this process could take several hours to complete. When the reinstallation completes, the NAS system shuts down.

 **NOTE:** During the reinstallation, do not attempt to connect to your NAS system.

22. After the NAS system shuts down, reconfigure the system.

See "[Configuring the NAS System for the First Time](#)" in "Initial Configuration."

Network With a DHCP Server

If your network has a dynamic host control protocol (DHCP) server and you have a Windows 2000 client on the same network, use the procedure in this section to reinstall your NAS system's operating system.

 **NOTE:** This procedure resets your NAS system to the Dell default settings and deletes all data on the NAS system. Before performing this procedure, attempt to boot from the operating system image on the mirrored hard drives. See "[Booting From the Recovery Operating System Mirror Hard Drives](#)."

If your network has a DHCP server, you need the following to reinstall the operating system:

- Serial cable included with your NAS system.
- Windows 2000 (Professional or Server Family) client system on the same subnet as the NAS system.

 **NOTE:** The system being used for the installation is *not* the DHCP server.

- *Resource* CD included with your NAS system.
- *Reinstallation* CD included with your NAS system.
- Existing DHCP service in the LAN.

To reinstall your NAS operating system, perform the following steps:

 **NOTICE:** This procedure deletes all of the data on your NAS system.

1. Shut down the NAS system, and do not turn it back on until instructed.

See "[Shutting Down the NAS System](#)" in "NAS Manager."

2. Turn off the client system, if it is running.

3. Connect the serial cable between the COM port on the NAS system and the COM port on the Windows 2000 client system.
4. Turn on the Windows 2000 client system.
5. Log in to the client system with an account that has administrator privileges.
6. Create a new user with the name `pv715` and the password set to `password`:
 - a. From the desktop of your client system, right-click **My Computer**, and then select **Manage**.
 - b. On the left side of the **Computer Management** window, double-click **Local Users and Groups**.
 - c. Right-click **Users** and select **New User**.
 - d. In the **New User** window, type `pv715` as the user name.
 - e. Type `password` for the password, and type it again in **Confirm password**.
 - f. Click **User must change password at next logon** to clear the check box.
 - g. Click **Create** and then click **Close**.
7. Create a share for the CD drive on the client system:
 - a. Double-click **My Computer**.
 - b. Right-click the CD drive, and select **Sharing**.
 - c. Type `CD` for the name of the share, and then click **OK** to confirm the share settings.
8. Install the Dell Reinstallation Console from the *Resource* CD:
 - a. Insert the *Resource* CD into the CD drive of your client system.

The **Dell PowerVault 715N Resource CD** screen displays in a browser window.



NOTE: If the CD does not run automatically, double-click the **start.bat** file on the CD.

- b. Click **Resources**.
 - c. Click **Install Reinstallation Console**.
 - d. When the **File Download** window displays, click **Open this file from its current location**, and then click **OK**.
 - e. Click **Next** and follow the instructions on the screen.
 - f. When prompted to reboot the client system, click **Yes**.
9. Create a reinstallation diskette from the *Resource* CD:
 - a. Make sure the *Resource* CD is in the CD drive of your client system.
 - b. In the *Resource* CD **Main Menu** window displays, click **Resources**.
 - c. In the **Resources** window, click **Reinstallation Diskette**.
 - d. When the **File Download** window displays, click **Run this program from its current location**, and then click **OK**.
 - e. Click **Yes** if you receive a security warning.

A DOS screen appears and prompts you to insert a diskette into the diskette drive of the client system.

- f. Insert a formatted diskette into the diskette drive of your client system, and then press <Enter>.

The DOS screen closes after the reinstallation diskette is made.

10. Edit the **go.bat** file for the renamed client system and CD drive:

- a. In Windows Explorer, right-click the **go.bat** file on the diskette, and then select **Edit** to edit the file to the following variable value for your environment:

`\\server_name\\share_name`, where *server_name* is the name of the client system and *share_name* is the name of the CD drive share (for example, `\\PV715\CD`)

- b. Save and exit the **go.bat** file.

11. Update the boot image:

- a. If it is not still in the diskette drive, insert the reinstallation diskette that you created in step 9 into the diskette drive of the networked Windows 2000 client system.
- b. Click the **Start** button and point to **Programs® Dell Reinstallation Console® Update boot image**.
- c. Remove the diskette from the diskette drive, and then reboot the client system.

12. If the *Resource CD* is still in the CD drive, remove it.

13. Insert the *Reinstallation CD* in the CD drive.

14. Start the Intel PXE Server and verify that the services are running.

- a. Click the **Start** button and point to **Programs® Dell Reinstallation Console® Intel PXE Service**.
- b. In the **PXE Configuration Utility** window right-click the server name, **PV715REC**, and then select **Start/Stop Services**.
- c. Verify that the proxy DHCP/Boot PXE and M/TFTP services are installed and running correctly by selecting **Stop** and then selecting **Start**.

If the services are running, the indicator should display *Started* after you click **Start** and *Stopped* after you click **Stop**.

- d. Click **OK**.

15. On the Intel PXE server software, configure the system to listen to the DHCP port by performing the following steps:

- a. Right-click **proxyDHCP Server Name**, and select **Configure proxyDHCP Server**.
- b. In the **Configure proxyDHCP Server** window, click the **Use DHCP Port for Listening** check box.
- c. Close and re-open the PXE server software.

16. On the client system, create a HyperTerminal connection:

- a. Click the **Start** button and point to **Programs® Accessories® Communications® HyperTerminal**.
- b. In the **Connection Description** window, enter any name for the connection, and then click **OK**.
- c. In the **Connect To** window, use the **Connect using** drop-down menu to select the correct local COM port.

The COM port is the communication port on the client system to which the serial cable connects. The COM port used on your client system is typically labeled COM1 or COM2.

- d. Click **OK**.
- e. In the **COMx Properties** window, set bits per second to **115,200** baud and flow control to **Xon/Xoff**.
- f. Click **OK**.

17. Turn on your NAS system.

18. In the **HyperTerminal** window, press <F2> immediately after you see the following message:

Press <F2> to enter the Function Select menu.

 **NOTE:** If you use a version of Microsoft Windows 2000 operating system earlier than Service Pack 2, the function keys do not work. You must press <Esc><2>.

19. From the menu, select option 3, **Reinstallation**, and then type *y* to confirm the selection.

The NAS system automatically reboots and begins the reinstallation process, which restores the NAS system back to the Dell default settings.

20. When the screen warns that you are going to reinstall and that it will erase data, type *y*.
21. Press *y* again to confirm the selection.

Depending upon your configuration, this process could take several hours to complete. When the reinstallation completes, the NAS system shuts down.

During the reinstallation, do not attempt to connect to your NAS system.

22. After the NAS system shuts down, reconfigure the system.

See "[Configuring the NAS System for the First Time](#)" in "Initial Configuration."

Using an Existing PXE Server

 **NOTE:** This procedure resets your NAS system to the Dell default settings. Before performing this procedure, attempt to boot from the operating system image on the mirrored hard drives. See "[Booting From the Recovery Operating System Mirror Hard Drives](#)."

If your network has a PXE server, you need the following to reinstall the operating system:

- Serial cable included with your NAS system
- Windows 2000 (Professional or Server Family) client system on the same subnet as the NAS system
- *Resource* CD included with your NAS system
- *Reinstallation* CD included with your NAS system
- An existing PXE server on the same network

To reinstall the main operating system with Dell default settings on hard disk 0 from an existing PXE server, perform the following steps:

1. Shut down the NAS system, and do not turn it back on until instructed.

See "[Shutting Down the NAS System](#)" in "NAS Manager."

2. Insert the *Reinstallation* CD in to the CD drive on the PXE server.
3. Create a share for the CD drive on the client system:
 - a. Double-click **My Computer**.
 - b. Right-click the CD drive, and select **Sharing**.
 - c. Type *CD* for the name of the share, and then click **OK** to confirm the share settings.
4. Turn off the Windows 2000 client system if it is turned on.
5. Connect the serial cable between the COM port on the NAS system and the COM port on the Windows 2000 client system.

The COM port is the communication port on the client system to which you connected the serial cable in step 1. The COM port used on your client system is typically labeled COM1 or COM2.

6. Turn on the client system and log on as an administrator.
7. Create a reinstallation diskette from the *Resource* CD:

- a. Insert the *Resource* CD into the CD drive of your client system.
- b. When the *Resource* CD **Main Menu** window displays, click **Resources**.
- c. On the **Resources** window, click **Reinstallation Diskette**.
- d. When the **File Download** window displays, click **Run this program from its current location**, and then click **OK**.
- e. Click **Yes** if you receive a security warning.

A DOS screen appears and prompts you to insert a diskette into the diskette drive of the client system.

- f. Insert a formatted diskette into the diskette drive of your client system, and then press <Enter>.

The DOS screen closes after the reinstallation diskette is made.

8. Edit the reinstallation diskette for your environment:
 - a. From the client system, browse to the reinstallation diskette.
 - b. Right-click the file named **go.bat** on the reinstallation diskette, and then select **Edit** to edit the file to the following variable values for your environment:
 - o *SHARE*, where *SHARE* is the share resource for the *Reinstallation* CD in the form \\pxe_server_name\cd_share_name
 - o *USER*, where *USER* is the Windows user who is to access the share resource
 - o *PASSWD*, where *PASSWD* is the password for the user who is to access the share resource
9. Install the customized reinstallation diskette image, which you just created on your client system, on your PXE server.

For more information, see your PXE server documentation.

10. On the client system create a HyperTerminal connection:
 - a. Click the **Start** button and point to **Programs® Accessories® Communications® HyperTerminal**.
 - b. In the **Connection Description** window, enter any name for the connection, and then click **OK**.
 - c. In the **Connect To** window, use the **Connect using** drop-down menu to select the correct local COM port.

This is the port to which your serial cable is connected.
 - d. Click **OK**.
 - e. In the **COMx Properties** window, set bits per second to **115,200** baud and flow control to **Xon/Xoff**.
 - f. Click **OK**.

11. Turn on your NAS system.

12. In the **HyperTerminal** window, press <F2> immediately after you see the following message:

Press <F2> to enter the Function Select menu.



NOTE: If you use a version of Microsoft Windows 2000 operating system earlier than Service Pack 2, the function keys do not work. You must press <Esc><2>.

13. From the menu, select option 3, **Reinstallation**, and then type *y* to confirm the selection.

The NAS system automatically reboots and begins the reinstallation process, which restores the NAS system back to the Dell default settings.

14. When the screen warns that you are going to reinstall and that it will erase data, type *y*.

15. Press *y* again to confirm the selection.

Depending upon your configuration, this process could take several hours to complete. When the reinstallation completes, the NAS system shuts down.

 **NOTE:** During the reinstallation, do not attempt to connect to your NAS system.

16. After the NAS system shuts down, reconfigure the system.

See "[Configuring the NAS System for the First Time](#)" in "Initial Configuration."

Restoring System-State Data After Reinstallation

To restore your system-state data, you must have previously backed up your system using the backup and recovery tools. See "[Backing Up System-State Data](#)" in "Backing Up the System."

 **NOTE:** If you are not restoring system-state data after reinstalling the operating system, perform the procedure in "[Restoring System-State Data](#)" in "Backing Up the System."

To restore system-state data, perform the following steps:

1. Log in to the NAS Manager.

See "[Logging in to the NAS Manager](#)."

2. Click **Maintenance**.
3. Click **Backup**.
4. In the **Log on to Windows** window, enter the same user name and password that you used to log in to the NAS Manager and click **OK**.

The **Welcome to Windows 2000 Backup and Recovery Tools** window displays.

5. Click **Restore Wizard**.
6. In the **Restore Wizard** window, click **Next**.
7. Click **Import File**.
8. In the **Backup File Name** window, click **OK** if the file and location are correct. Otherwise, click **Browse** and navigate to the correct backup file location.

 **NOTE:** NOTE: If the **.bkf** file is in another system you must copy the file to the NAS system or map a share to the file before restoring.

9. In the **What to Restore** window, click **(+)** to expand the **File** tree, and then click to expand **Media created yyyy/mm/dd**, where *yyyy/mm/dd* is the year/month/date that you made the system-state backup.
10. Click the **(+)** next to **System State**.
11. In the **Backup File Name** window, click **OK** if the file and location are correct. Otherwise, click **Browse** and navigate to the correct backup file location.
12. Click **System State** so that it is checked, and then click **Next**.
13. Click **Advanced**.
14. In the **Where to Restore** window, select **Original location** from the drop-down menu as the location to restore the files, and then click **Next**.
15. In the **How to Restore** window, click **Always replace the files on disk**, and then click **Next**.
16. In the **Advanced Restore Options** window, leave all check boxes unchecked and click **Next**.

17. Click **Finish**.
18. When the **Enter Backup File Name** window displays, click **OK**.

 **NOTE:** If your backup file is in a different location, click **Browse** and navigate to the file.

19. Click **Start Restore**.
20. When a message warns that the system restore will overwrite the current system state, click **OK**.
21. Click **OK** in the **Confirm Restore** window.
22. Restart the NAS system after the restore process completes.

 **NOTE:** Windows must replace all locked files on the system; therefore, the process of restarting the system might take approximately 15 minutes to complete.

Restoring Initial System Setup

After the operating system is reinstalled on the system, the NAS system is set back to factory defaults. Make sure you configure the system again to establish network communication. For information about configuring your system, see "[Initial Configuration](#)."

[Back to Contents Page](#)

Dell ActiveArchive

Dell™ PowerVault™ 715N NAS Systems Administrator's Guide

- [Introduction to Persistent Images](#)
- [Configuring the Persistent Image Global Settings](#)
- [Configuring Persistent Image Volume Settings](#)
- [Using Persistent Images](#)
- [Scheduling Persistent Images](#)
- [Accessing Stored Persistent Images](#)
- [Restoring Volumes From an Existing Persistent Image](#)
- [Changing the Dell ActiveArchive Event Log Language](#)
- [Defragmenting a Volume Containing Persistent Images](#)

Dell ActiveArchive™ allows the creation and preservation of persistent images of Dell™ PowerVault™ 715N system data volumes. The Dell ActiveArchive software is available for all PowerVault 715N systems. It can be configured by using the NAS Manager.

Introduction to Persistent Images

A persistent image is a point-in-time copy of a disk volume. A persistent image contains an exact copy of the file system at the time the persistent image was created. If you change a file on the active file system after taking a persistent image, the persistent image contains the old version of the file. If an active file gets corrupted or deleted, you can restore the old version by copying the file from the latest persistent image or restoring the entire volume. Also, because the persistent image contains the contents of the file system when the persistent image was taken, you can perform a backup from the persistent image without stopping all I/O to the file servers, thus eliminating the backup window required by other types of backup.

- ➡ **NOTICE:** Persistent images are temporary backups of your data that reside on the same volume as your data. If the volume becomes damaged, you lose your data, including the persistent image. Therefore, persistent images do not replace regular backups of your volume.

Cache File

The Dell ActiveArchive software stores changed data in a cache file. A cache file resides on each volume of your system. By default, the persistent image cache file is 20 percent of each volume. You can use the NAS Manager to change the percentage of the volume that is dedicated to the cache file.

- 📎 **NOTE:** You cannot take a persistent image of the operating system volumes or the recovery operating system drives (C or D).

Cache Thresholds

The Dell ActiveArchive software has two thresholds that provide warnings when the cache file is approaching maximum capacity. The warning threshold logs an event in the event log and displays a warning in the NAS Manager status indicator when the cache file reaches the threshold (default is 80 percent full). The deletion threshold, which is labeled "Begin deleting images" in the NAS Manager, specifies the threshold at which the PowerVault NAS Manager deletes the oldest persistent images with the lowest retention weights until the cache file is below the deletion threshold (default is 90 percent full). The NAS Manager indicates when it deletes persistent images to get below the threshold by displaying an error on the NAS Manager **Status** page.

Persistent Image Retention Weights

When the cache file reaches the deletion threshold, the system starts deleting files, depending on the retention weight and age of the persistent image. The system first looks for the persistent image with the lowest retention weight in the cache file. It then deletes the oldest persistent image with the lowest retention weight until the cache file is below the deletion

threshold. After all persistent images with the lowest retention weight have been deleted, Dell ActiveArchive looks for and deletes the oldest files with the next lowest retention weight.

Persistent Image Considerations

When using persistent images, system performance might be degraded, depending on the rate your data is changing and the number of persistent images kept for each virtual disk. Read performance of the virtual disk remains constant, regardless of the presence of persistent images. Read performance of the persistent image is identical to that of the virtual disk. Write performance, however, might vary. Each initial write to a virtual disk area causes the Dell ActiveArchive software to rewrite the data to the persistent image cache file, and the initial write is slower if the data is being protected by a persistent image. Changes to data that is not protected by a persistent image does not cause a performance degradation.

Storing Persistent Images

You can configure the NAS system to store a maximum of 250 persistent images per volume; however, if you exceed the maximum, the oldest persistent image with the lowest retention weight is overwritten. This number of persistent images allows you to schedule multiple persistent images. (You should tailor your schedule depending on how the data is changing.) For example, you could implement a schedule similar to the following schedule:

- Seven daily persistent images with a high priority
- Two weekly persistent images with a medium priority
- Two monthly persistent images with a low priority

This type of schedule gives you good snapshot coverage and ensures that your most recent data has the highest priority.

Configuring the Persistent Image Global Settings

You can modify the various aspects of the persistent image environment by performing the following steps:

1. Log in to the NAS Manager.

See "[Logging in to the NAS Manager](#)" in "NAS Manager."

2. Click **Disks**.
3. Click **ActiveArchive**.
4. Click **Global Settings**.
5. Configure the following options.



NOTE: Before changing the image directory name, you must delete all existing persistent images.

- **Maximum persistent images** — Specifies the maximum number of active persistent images per volume, up to a maximum of 250. When the volume has 250 persistent images stored, starting another persistent image overwrites the oldest persistent image with the lowest retention weight.
- **Inactive period** — Prior to starting a persistent image, the system waits for a period of relative inactivity on the volume being imaged. The default value for this period, which is 5 seconds, allows systems to start an image with a consistent file set and a minimal time-out. Experienced administrators may reduce or increase this value for system optimization. Reducing the inactive period allows persistent images to begin on systems where disk inactivity is rare, at the possible expense of synchronization problems within applications that are concurrently writing to multiple files.
- **Inactive time-out** — Specifies the amount of time the server continues to retry to create a persistent image (default time is 15 minutes). A persistent image cannot start until a period of relative inactivity, specified by **Inactive period**, occurs. If an interval longer than **Inactive time-out** passes before the persistent image can begin, the persistent image cannot be taken and an error is displayed in the NAS Manager status indicator and logged in the event log.
- **Image directory** — Specifies the directory name that is to be used for the persistent image mount point. Each persistent image appears as a subdirectory in the volume that is being imaged. The entire content of

the volume, as it existed when the persistent image was created, appears under this directory.

6. If you need to re-establish the system defaults, click **Restore Defaults**.
7. Click **OK** to update the global settings.

Configuring Persistent Image Volume Settings

You can modify volume settings by performing the following steps:

1. Log in to the NAS Manager.

See "[Logging in to the NAS Manager](#)" in "NAS Manager."

2. Click **Disks**.
3. Click **ActiveArchive**.
4. Click **Volume Settings**.
5. Click the volume setting that you want to change.
6. Click **Configure**.
7. Use the appropriate menus to configure the following options.



NOTE: Before changing the cache size, you must delete all persistent images on that volume.

- **Warning threshold reached when** — Defines the percentage of cache space used that triggers warning messages to the system event log.
- **Begin deleting images when** — Defines the percentage of cache space used that triggers automatic deletion of the oldest persistent images with the lowest retention weight on the system. Automatic persistent image deletions are recorded in the system log.
- **Cache size** — Specifies the percentage of the volume that is allocated to the cache file. Increasing this value allows more and larger persistent images to be maintained. Ensure that adequate space is available on the persistent image files' location drive.

8. If you need to re-establish the system defaults, click **Restore Defaults**.
9. Click **OK**.

Using Persistent Images

In addition to scheduling persistent images, you can take new persistent images on demand, delete existing persistent images, configure the persistent image environment, and set persistent image retention weights.

Taking a New Persistent Image on Demand

1. Log in to the NAS Manager.

See "[Logging in to the NAS Manager](#)" in "NAS Manager."

2. Click **Disks**.
3. Click **ActiveArchive**.
4. Click **Persistent Images**.

5. In the **Tasks** list on the **Persistent Images** page, click **New**.
6. In the menu that is displayed, select the **Volume(s)** to preserve.

Consider the following when selecting the volume(s):

- You can take persistent images only of volumes with drive letters, not volumes mounted to a directory (mount points).
- If volumes are not protected by RAID 1 or 5 or if volumes are frequently being added and removed, Dell recommends that you make persistent images of individual volumes. Because multivolume persistent images are linked to each other, a multivolume persistent image may become inaccessible if one volume in the multivolume persistent image fails or is removed from the system.



NOTE: To select multiple volumes, press and hold <Ctrl> and select all volumes that are to be included in the persistent image.

7. Select the **Read Only** or **Read/Write** attribute.
8. Select the retention weight for the persistent image.
9. Confirm the persistent image name.

You can use patterns in the persistent image name to differentiate your persistent images. For example if you use a pattern of **Snapshot.%i** and you take two persistent images, you have **Snapshot.1** and **Snapshot.2**. The default persistent image name pattern is **Snapshot %M-%D-%Y %H.%m.%s**. Valid pattern macros are as follows:

- %M = Month
- %D = Day
- %Y = Year
- %h = Hours in 12-hour format
- %H = Hours in 24-hour format
- %m = Minute
- %s = Second
- %i = Instance, which increments once per instance
- %a = AM/PM
- %W = Day of the week
- %w = Three-letter day of the week
- %% = Percent sign

10. Click **OK** to create the persistent image.

Deleting a Persistent Image

1. Log in to the NAS Manager.

See "[Logging in to the NAS Manager](#)" in "NAS Manager."

2. Click **Disks**.
3. Click **ActiveArchive**.
4. Click **Persistent Images**.
5. Click the check box next to the persistent image that is to be deleted.

6. In the **Tasks** list, click **Delete**.
7. Click **OK** to delete the persistent image.

Undoing Writes to a Read/Write Persistent Image

To undo writes to a read/write persistent image, you must select an item from the **Persistent Images** list and then click **Undo** in the **Tasks** list.

To undo persistent image writes, perform the following steps:

1. Log in to the NAS Manager.

See "[Logging in to the NAS Manager](#)" in "NAS Manager."

2. Click **Disks**.
3. Click **ActiveArchive**.
4. Click the persistent image to be restored to its original state.
5. Click **OK** to restore the image or **Cancel** to leave it intact.

Setting Persistent Image Retention Weights and Read Only or Read/Write Attributes

To change the read only or read/write attribute or the retention weight (deletion priority) of an image, you must edit the persistent image properties by selecting an image from the **Persistent Image** list, and then clicking **Properties** in the **Tasks** list.

To edit the persistent image properties, perform the following steps:

1. Log in to the NAS Manager.

See "[Logging in to the NAS Manager](#)" in "NAS Manager."

2. Click **Disks**.
3. Click **ActiveArchive**.
4. Click **Persistent Images**.
5. Click the persistent image that you want to edit.
6. In the **Task** list, click **Properties**.
7. Select the **Read Only** or **Read/Write** attribute.
8. Select the retention weight.
9. Click **OK** to update the persistent image.

Scheduling Persistent Images

When you click **Disks® ActiveArchive® Schedules**, the **Scheduled Persistent Image** page displays a list of all scheduled persistent images and associated tasks. Each scheduled persistent image is identified by the scheduled time, day, frequency, starting date, and target volume ID. Persistent images are identified by time and date and are located in the **ActiveArchive** directory. The **ActiveArchive** directory is located in the root of each ActiveArchive volume. Only the administrator can access the **ActiveArchive** directory. The files and folders in the persistent image directories have the same permissions as the files and folders on the original volume. Persistent image directories are used exactly the same way as conventional system volumes. Unlike conventional volumes, read-only persistent image images are static, recording the precise content of the originating volume at the time you created the persistent image.

Displaying the List of Persistent Images

The **Persistent Images** page displays all current active persistent images. Each entry identifies the date and time that the persistent image was created and the volume it preserves. Select an individual persistent image by clicking the radio button to the left of the description.

1. Log in to the NAS Manager.

See "[Logging in to the NAS Manager](#)" in "NAS Manager."

2. Click **Disks**.
3. Click **ActiveArchive**.
4. Click **Persistent Images**.

Adding Persistent Images to the Schedule

1. Log in to the NAS Manager.

See "[Logging in to the NAS Manager](#)" in "NAS Manager."

2. Click **Disks**.
3. Click **ActiveArchive**.
4. Click **Schedules**.
5. In the **Tasks** list on the **Persistent Image Schedules** page, click **New**.
6. Use the menus to select the start time (**Start at**), the frequency at which to repeat the persistent image (**Repeat every**), the day to begin (**Begin**), the volume(s) to include, the image attributes (**Read-only** or **Read/Write**), the retention weight, number of images to save (per schedule), and the persistent image name.

 **NOTE:** To select multiple volumes, press and hold <Ctrl> and select all volumes that are to be included in the persistent image.

 **NOTE:** If volumes are not protected by RAID 1 or 5 or if volumes are frequently being added and removed, Dell recommends that you make persistent images of individual volumes. Because multivolume persistent images are linked to each other, a multivolume persistent image may become inaccessible if one volume in the multivolume persistent image fails or is removed from the system.

You can use patterns in the persistent image name to differentiate your persistent images. For example if you use a pattern of **Snapshot.%i** and you take two persistent images, you have **Snapshot.1** and **Snapshot.2**. The default persistent image name pattern is **Snapshot %M-%D-%Y %H.%m.%s**. Valid pattern macros are as follows:

- %M = Month
- %D = Day
- %Y = Year
- %h = Hours in 12-hour format
- %H = Hours in 24-hour format
- %m = Minute
- %s = Second
- %i = Instance, which increments once per instance
- %a = AM/PM
- %W = Day of the week
- %w = Three-letter day of the week

- %% = Percent sign

7. Click **OK** to save the new scheduled persistent image.

Deleting a Persistent Image Schedule

1. Log in to the NAS Manager.

See "[Logging in to the NAS Manager](#)" in "NAS Manager."

2. Click **Disks**.

3. Click **ActiveArchive**.

4. Click **Schedules**.

5. On the **Persistent Image Schedules** page, click the check box next to the scheduled persistent image to be deleted.

6. In the **Tasks** list on the **Persistent Image Schedules** page, click **Delete**.

7. Click **OK** to delete the item or **Cancel** to leave the item intact.

Editing the Properties of a Persistent Image Schedule

1. Log in to the NAS Manager.

See "[Logging in to the NAS Manager](#)" in "NAS Manager."

2. Click **Disks**.

3. Click **ActiveArchive**.

4. Click **Schedules**.

5. In the **Tasks** list on the **Persistent Image Schedules** page, click **Properties**.

6. Use the appropriate menus to select the starting time, the frequency at which to repeat the persistent image (**Repeat every frequency**), the day to begin, the volume(s), the image attributes (**Read-only** or **Read/Write**), and the number of images to save (per schedule).

 **NOTE:** To select multiple volumes, press and hold <Ctrl> and select all volumes that are to be included in the persistent image.

 **NOTE:** If volumes are not protected by RAID 1 or 5 or if volumes are frequently being added and removed, Dell recommends that you make persistent images of individual volumes. Because multivolume persistent images are linked to each other, a multivolume persistent image may become inaccessible if one volume in the multivolume persistent image fails or is removed from the system.

7. Click **OK** to modify the schedule or **Cancel** to leave the schedule intact.

Accessing Stored Persistent Images

 **NOTE:** Only Windows clients (CIFS) can access Dell ActiveArchive persistent images.

 **NOTE:** The name of the utility that creates persistent images is Dell ActiveArchive. The name of the directory where Dell ActiveArchive persistent images are stored is **ActiveArchive**.

1. Log in to the NAS Manager.

See "[Logging in to the NAS Manager](#)" in "NAS Manager."

2. Click **Maintenance**.
3. Click **Terminal Services**.
4. Log in to a **Terminal Services Advanced Client** session.
5. If the **PowerVault Advanced Administration Menu** window is displayed, click **Exit**, and then click **OK** to close it.
6. Use Microsoft® Windows® Explorer to navigate to the **ActiveArchive** directory on the volume root.

Accessing Directories, Folders, and Files

By default, administrators can access the **ActiveArchive** directory in the root of each volume. Each persistent image is displayed separately with a date and time stamp showing when the persistent image occurred. The administrator can browse the persistent image as if it were a standard volume. Each persistent image is mounted as a volume on the file system to allow access by clients. Persistent images are created as read-only or write-only.

Persistent image directories are used in the same way that conventional directories are used. The files and folders in the persistent image directories have the same permissions as the files and folders on the original volume. All persistent images are persistent and survive system power losses or reboots.

Allowing User Access to Persistent Images

The files and folders within a persistent image are identical to the permissions on the original files and folders. However, by default, the **ActiveArchive** directory is restricted to administrator access only. To allow users to access the persistent images, the system administrator must modify the permissions for the **ActiveArchive** directory.

Use the PowerVault NAS Manager to change the **ActiveArchive** directory permissions by performing the following steps:

1. Log in to the NAS Manager as an administrator.

See "[Logging in to the NAS Manager](#)" in "NAS Manager."

2. Click **Maintenance**.
3. Click **Terminal Services**.
4. Log in to a **Terminal Services Advanced Client** session.
5. Open Windows Explorer.
6. Select the drive on the left side.
7. Right-click the **ActiveArchive** directory, and then click **Properties**.
8. Click **Security**, and then click **Add**.
9. Click specific users or groups or type the individual users or group names to add individual users or groups, and then click **OK**.
10. Give the selected members **Read** and **List Folder Contents** permissions.
11. Click **OK**.

After setting the permissions for the **ActiveArchive** directory, perform the following procedure to allow the user access to a share on the directory:

1. Log in to the NAS Manager.

See "[Logging in to the NAS Manager](#)" in "NAS Manager."

2. Click **Shares**.
3. On the **Shares** page, click **Shares**.

4. In the **Tasks** list on the **Shared Folders** page, click **New**.
5. Type the share name `ActiveArchives` and path `volume_letter:\ActiveArchives`, where `volume_letter` is the volume of the persistent images.

 **NOTE:** Ignore the **Comment** field for NFS, FTP, and HTTP shares.

6. Check the **Microsoft Windows (CIFS)** box.
7. Click **CIFS Sharing** and add the users that you want to have access to persistent images.
8. Click **OK**.

Users can access persistent images from a Windows 2000 client by performing the following steps:

1. Right-click **My Appliance**, and select **Map Network Drive**.
2. Map to the `ActiveArchives` directory as a user that has permissions to the `ActiveArchives` share.
3. For **Folder**, type `\\Dellxxxxxxx\ActiveArchives`, where `Dellxxxxxxx` is the name of the NAS system.

The default system name is `Dellxxxxxxx`, where `xxxxxxx` is the system's service tag number. For example, if your service tag number is 1234567, enter `DELL1234567`. You can find the service tag number on the top cover of your NAS system.

4. Use Windows Explorer to navigate to the **ActiveArchive** directory on the newly mapped drive.

Naming Files in Microsoft Windows Explorer

Windows Explorer has a limitation of 255 characters in a filename, including the path. When you make a persistent image, the entire path and filename are stored in addition to the Dell `ActiveArchives` default path and persistent image name. The default Dell `ActiveArchives` naming convention would result in a name such as the following:

```
Drive_Letter:\ActiveArchives\Snapshot 01-01-2001 12.00.00\Path_and_Filename
```

The original path and filename and the Dell `ActiveArchives` default path might exceed the 255-character limit and become inaccessible through Windows Explorer.

If a file becomes inaccessible because of the 255-character limit, perform the following steps to ensure that you can access long path and file names in Windows Explorer:

1. Create a share for the desired snapshot folder. For example:



```
E:\ActiveArchives\Snapshot 01-01-2001 12.00.00\
```

2. Access that share through the desired client.

The path and filename no longer include the additional directory information, which shortens the path and filename to the original character length. You can now access the file through Windows Explorer.

Restoring Volumes From an Existing Persistent Image

To restore a volume(s) from a persistent image, you must select the persistent image to be restored. Ensure that you select the persistent image carefully because any activity that occurred after the persistent image was taken is lost.

-  **NOTICE:** Restoring a volume restores the volume back to the state of the volume at the time the persistent image was made. This restore destroys all data on the volume and replaces it with the data from the persistent image.
-  **NOTICE:** A volume is dismounted during a restore. All reads and writes to a volume that occur during the restore process are denied. Therefore, you must stop all I/O traffic to a volume while restoring it.

To restore volumes from a persistent image, perform the following steps:

1. Log in to the NAS Manager.

See "[Logging in to the NAS Manager](#)" in "NAS Manager."

2. Click **ActiveArchive**.
3. Click **Restore Persistent Images**.
4. Click the persistent image that is to be restored.
5. Click **Restore**.
6. Click **OK** to restore the volumes protected by the persistent image, or click **Cancel** to leave the volume intact.

 **NOTE:** Restoring persistent images that contain multiple volumes restores all of the volumes in the persistent image. If you want the ability to restore a single volume, you must take single volume persistent images.

 **NOTE:** If you delete a share from a volume after a snapshot is taken, that share will not be accessible after you restore the snapshot. For example, if you create a persistent image of volume E, which has a share called "users," and you later delete "users," when you restore volume E, the "users" share will not be accessible, although the directory will still exist and contain the files.

Changing the Dell ActiveArchive Event Log Language

Applying a selected language changes the graphical user interface to that language, but it does not change the language in which the Dell ActiveArchive event log messages are generated. The messages are generated in English unless you run a batch file to change the language to one of the following supported languages:

- English
- French
- German
- Japanese
- Spanish

To change the language in which the event log messages are generated, perform the following steps:

1. Log in to the NAS Manager.

See "[Logging in to the NAS Manager](#)" in "NAS Manager."

2. Click **Maintenance**.
 3. Click **Terminal Services**.
 4. Log in to the system as administrator.
 5. If the Advanced Administration Menu is open, click **Exit**, and then **OK** to close it.
 6. Open the Microsoft Windows Explorer, expand the hard drive C directory and the **Dell** directory.
 7. Open the **AArchive_Langpatch** directory.
 8. Double-click the appropriate batch file, such as the **english.bat** file for English or the **japanese.bat** file for Japanese.
 9. After the batch file has run, reboot your system.
-

Defragmenting a Volume Containing Persistent Images

 **NOTICE:** Defragmenting a volume containing persistent images without using the following procedure can corrupt your persistent images and degrade your system performance.

 **NOTE:** If you do not have persistent images on your volume, this procedure does not apply.

 **NOTE:** To defragment a volume, you must delete all persistent images on that volume.

To defragment a volume containing persistent images, perform the following steps:

1. Log in to the NAS Manager.

See "[Logging in to the NAS Manager](#)" in "NAS Manager."

 **NOTE:** The default administrator user name is `administrator` and the default password is `powervault`.

2. Click **Disks**.
3. Click **ActiveArchive**.
4. Click **Schedules**.
5. Select a scheduled persistent image, and then click **Delete**.
6. Repeat until all scheduled persistent images are deleted.
7. Click **Back**.
8. Click **Persistent Images**.
9. Select a persistent image, and then click **Delete**.
10. Repeat until all persistent images are deleted.
11. Click **Maintenance**.
12. Click **Terminal Services**.
13. Log in to the NAS system.
14. Click **Exit** to close the Advanced Administration Menu.
15. Double-click **My Appliance**.
16. Right-click the drive that you want to defragment, and click **Properties**.
17. Click **Tools**.
18. Click **Defragment Now**.

The **Defragmentation** window displays.

19. Click **Defragment**.

You are notified when defragmentation is complete.

20. Exit **Terminal Services Client**.
21. Reschedule your persistent images for this volume.

Advanced Features

Dell™ PowerVault™ 715N NAS Systems Administrator's Guide

- [Using Console Redirection](#)
- [Installing Multilanguage User Interface \(MUI\) Support](#)
- [Installing and Configuring Support for Other Languages](#)
- [Network Adapter Teaming](#)
- [Services for UNIX®](#)
- [File Server for Macintosh](#)
- [Services for Novell® NetWare®](#)
- [Microsoft Directory Synchronization Services](#)
- [Using Secure Sockets Layers](#)
- [SNMP Considerations](#)

This section includes descriptions of advanced features that cannot be performed from the Dell™ PowerVault™ NAS Manager menus.

To perform the procedures in this section, you must use the Terminal Services Advanced Client. To access the Terminal Services Advanced Client, perform the following steps:

1. Log in to the NAS Manager.

See "[Logging in to the NAS Manager](#)" in "NAS Manager."

2. From the NAS Manager, click **Maintenance**.
3. Click **Terminal Services**.
4. Log on as an administrator.

 **NOTE:** The default administrator user name is `administrator` and the default password is `powervault`.

Using Console Redirection

Console redirection allows you to view the NAS system's power-on self-test (POST) and change BIOS settings from a client system. Console redirection redirects keyboard input and text output through the serial port. Graphic output is not redirected. This section describes the simplest connection possible: connecting to a system with a serial cable.

Minimum Hardware and Connection Requirements

To use console redirection, you must have the following:

- An available serial port (COM port) on a client system. (This port must not conflict with any other ports on the system.)
- An available serial port (COM 1) on the NAS system.

 **NOTE:** Console redirection is enabled by default in the NAS system BIOS.

- The serial cable provided with your NAS system.
- Hyperterminal installed on the client system. If Hyperterminal is not installed on the client system, you can install it from your operating system CD.

Setting Up Console Redirection in Microsoft® Windows® 2000

 **NOTE:** You can use clients running operating systems other than Windows 2000 for console redirection. However, this section provides information for setting up console redirection only on a Windows 2000 client system. For console redirection information on other operating systems, see the operating system documentation.

To set up console redirection on a Windows 2000 client system to manage your NAS system, perform the following steps:

1. Connect a Windows 2000 client system to the NAS system:
 - a. Shut down the NAS system, and do not turn it back on until instructed.

See "[Shutting Down the NAS System](#)" in "NAS Manager."
 - b. Turn off the client system, if it is running.
 - c. Connect the serial cable between the COM port on the NAS system and the COM port on the Windows 2000 client system.

The COM port used on your client system is typically labeled COM1 or COM2.

2. Turn on the client system and set up a Hyperterminal connection:
 - a. Click the **Start** button and point to **Programs® Accessories® Communications® Hyperterminal**.
 - b. Select **115200** for the bits per second, **8** for data bits, **None** for parity, **1** for stop bits, and **Xon\Xoff** for flow control.
3. Restart the NAS system.

You can now use your client system to manage your NAS system. If you need to configure your BIOS settings, see "Entering the BIOS Setup Utility" in your *User's Guide*.

Navigating With Console Redirection

Because of ANSI limitations, not all keys can be used with console redirection. [Table 7-1](#) shows the keystroke combinations used for the version of Windows on your client system.

Table 7-1. Console Redirection Keys

Normal Keys (As They Appear on the Keyboard)	Keys Used for Windows 2000 Prior to Service Pack 2 and Windows XP	Keys Used for All Other Windows Operating Systems
Home	<Esc><h>	<Esc><h>
End	<Esc><k>	<Esc><k>
Insert	<Esc><+>	<Esc><+>
Delete	<Esc><->	<Esc><->
Page Up	< Esc><?>	<Page Up>
Page Down	<Esc></>	<Page Down>
F1	<Esc><1>	<F1>
F2	<Esc><2>	<F2>
F3	<Esc><3>	<F3>
F4	<Esc><4>	<F4>
F5	<Esc><5>	<Esc><5>
F6	<Esc><6>	<Esc><6>
F7	<Esc><7>	<Esc><7>

F8	<Esc><8>	<Esc><8>
F9	<Esc><9>	<Esc><9>
F10	<Esc><0>	<Esc><0>
F11	<Esc><!>	<Esc><!>
F12	<Esc><@>	<Esc><@>
Up arrow	<Esc><w>	Up arrow
Right arrow	<Esc><a>	Right arrow
Left arrow	<Esc><d>	Left arrow
Down arrow	<Esc><x>	Down arrow
<Ctrl><Alt><Delete>	<Esc><Shift><r> <Esc><r> <Esc><Shift><r> OR <Esc><Shift>	<Esc><Shift><r> <Esc><r> <Esc><Shift><r> OR <Esc><Shift>

Installing Multilanguage User Interface (MUI) Support

 **NOTE:** Installing the MUI for your language automatically installs the appropriate language locale.

The PowerVault 715N NAS system allows you to change languages for its Microsoft Windows Powered operating system's user interface. The MUI allows the PowerVault 715N to display Windows Powered operating systems menus, dialogs, and help files in multiple languages. The supported MUI languages are simplified Chinese, traditional Chinese, Dutch, English, French, German, Italian, Japanese, Korean, Spanish, and Swedish. You must install a language MUI from the *Multilingual Support* CD before it can be used on the system. When you receive a PowerVault 715N NAS system from Dell, the root directory of drive C includes a **localization** directory, which contains all of the files included in the *Multilingual Support* CD. If you have performed the reinstallation procedure, this directory does not exist, and you must install a language MUI from the *Multilingual Support* CD.

 **NOTE:** Installing and configuring the operating system MUI does not affect the language used by the NAS Manager.

1. Log in to the NAS Manager.

See "[Logging in to the NAS Manager](#)" in "NAS Manager."

2. Click **Maintenance**, and then click **Terminal Services**.
3. Log in to the system as an administrator.

 **NOTE:** The default administrator user name is `administrator` and the default password is `powervault`.

4. Close the Advanced Administration Menu by clicking **Exit**.
5. Double-click **My Appliance** on the NAS desktop.
6. If this is a new system, perform the following steps, and then go to step 8. Otherwise, go to step 7.
 - a. Double-click **Local Disk C:** to open the root directory.
 - b. Double-click the **localization** directory.
 - c. Double-click the **muisetup.exe** file to configure the language.
7. If you performed the reinstallation procedure on your system, perform the following steps:
 - a. In the **Sharing** tab on the **Compact Disk Properties** page, click the radio button next to **Share this folder** to share the CD drive, and then insert the *Multilingual Support* CD that came with your NAS system into your remote client system's CD drive.

- b. Map a network drive to the CD share, but *do not* select **Reconnect at logon**.
 - c. Browse to the mapped drive, and then double-click the CD icon to launch the *Multilingual Support CD's Web* interface.
 - d. Click the **Install Multilanguage User Interface (MUI) Support** link to launch the Multilanguage File Installation installer program.
8. In the installer window, select the languages to be installed, and select the default MUI language from the menu.
 9. Click **OK** to perform the installation.
 10. If the **Insert Disk** window appears, you must perform the following steps:
 - a. Click **OK**.
 - b. In the **Files needed** window, click **Browse**, browse to the **i386** directory on the *Multilingual Support CD* or in the **C:\localization** directory (which does not exist if you reinstall the operating system), and then click **Open**.
 - c. If the **Insert Disk** window displays, click **OK** to allow the operating system to find the required files for installation.
 11. Disconnect the mapped network drive from the CD share that you mapped in step 7.
 12. After the installation is complete and you have disconnected the network drive, you must reboot your system.

After a MUI language has been installed, you can apply it to any user by performing the following steps:

1. Log in to the NAS Manager.

See "[Logging in to the NAS Manager](#)" in "NAS Manager."

2. Click **Maintenance**, and then click **Terminal Services**.
3. Log in to the system as an administrator.

The default administrator user name is `administrator` and the default password is `powervault`.

4. On the Advanced Administration Menu, click **System Management**, and then click **Set Regional Options** to launch the **Regional Options** control panel.
5. On the **General** tab, select the MUI language from the **Your locale (location)** drop-down menu, and then click **Apply**.
6. Log off and log in to the system again for the new language MUI to take effect.

Installing and Configuring Support for Other Languages

 **NOTE:** Install additional language locales only if your preferred language is not available with MUI support or you need additional locale support.

The Windows Powered operating system that comes installed on the PowerVault 715N can be configured to support reading and writing documents in a number of languages. To install the software required to support a specific language, perform the following steps:

1. Log in to the NAS Manager.

See "[Logging in to the NAS Manager](#)" in "NAS Manager."

2. Click **Maintenance**, and then click **Terminal Services**.
3. Log in to the system as an administrator.

 **NOTE:** The default administrator user name is `administrator` and the default password is `powervault`.

4. Close the Advanced Administration Menu by clicking **Exit**.
5. Double-click **My Appliance** on the NAS desktop.
6. If this is a new system from Dell, perform the following steps, and then go to step 8. If you are performing this procedure after reinstalling your operating system, go to step 7.
 - a. Double-click **Control Panel**.
 - b. Double-click **Regional Options**.
7. If you performed the reinstallation procedure on your system, perform the following steps:
 - a. In Windows Explorer on a remote system, right-click the CD drive, and then click **Sharing**. In **Sharing** tab on the **Compact Disk Properties** page, click the radio button next to **Share this folder** to share the CD drive, and then insert the *Multilingual Support* CD that came with the PowerVault 715N into your remote system CD drive.
 - b. Map a network drive to the CD share, but *do not* select **Reconnect at logon**.
 - c. Browse to the mapped drive, and then double-click the *Multilingual Support* CD icon to launch the *Multilingual Support* CD's Web interface.
 - d. Click the **Install Language Locales Not Supported by MUI** link to launch the **Regional Options** control panel.
8. From the **Language Settings for the System** panel, select the languages to be configured.
9. Set the default language for the system by clicking **Select default...** and selecting the appropriate language from the menu, and then click **OK**.
10. Click **Apply** to complete the operation.
11. If the **Insert Disk** window appears, you must perform the following steps:
 - a. Click **OK**.
 - b. In the **Files needed** window, click **Browse**, browse to the **i386** directory on the *Multilingual Support* CD or in the **C:\localization** directory (which does not exist if you reinstall the operating system), and then click **Open**.
 - c. Click **Open**, and then click **OK** from the **Insert Disk** window to allow the operating system to find the required files for installation.
12. After the installation is complete, if applicable, disconnect the mapped network drive from the CD share that you mapped in step 7.
13. Reboot your system.

 **NOTE:** For more information, see the Microsoft Windows Powered operating system's online help.

Network Adapter Teaming

Network adapter teaming allows the system to use the combined throughput of multiple network ports in parallel to increase performance or to provide fault tolerance. Network adapter teaming on your NAS system supports the following technologies:

- Adaptive Load Balancing (ALB) from Intel®
- Adapter Fault Tolerance (AFT) from Intel
- Link Aggregation
- Fast EtherChannel (FEC)
- IEEE 802.3ad

 **NOTE:** When creating or removing teams, the IP address of the NAS system's LAN connections changes. To prevent disconnecting from the NAS system during team configuration, use a serial connection when creating or removing teams. See "[Configuring Your System Using a Serial Connection](#)" in "Initial Configuration" before configuring your teams.

Adaptive Load Balancing

Adaptive Load Balancing (ALB) is a simple and efficient method for increasing the NAS system's network transmission throughput. The ALB software continuously analyzes transmission loading on each adapter and balances the load across the teamed ports as needed. Adapter teams configured for ALB also provide the benefits of adapter fault tolerance. To use ALB, the Ethernet ports on the NAS system must be linked to the same Ethernet switch.

Adapter Fault Tolerance

Adapter Fault Tolerance (AFT) provides the safety of an additional backup link between the NAS system and the hub or switch. If a hub, switch port, cable, or Ethernet port fails, you can maintain uninterrupted network performance. AFT is implemented with a primary adapter and a backup, or secondary, adapter. If the link to the primary adapter fails, the link to the secondary adapter automatically takes over.

Link Aggregation

Link aggregation is a performance technology developed by Intel and others to increase a system's network throughput. Unlike ALB, link aggregation can be configured to increase both transmission and reception channels between your system and switch. Link aggregation works only with compatible Intel switches. To use link aggregation, the Ethernet ports of the NAS system must be linked to the same Intel Ethernet switch.

Fast EtherChannel

Fast EtherChannel (FEC) is a performance technology developed by Cisco Systems to increase a system's network throughput. Unlike ALB, FEC can be configured to increase both transmission and reception channels between your NAS system and switch. FEC works only with compatible Cisco switches. To use FEC, the Ethernet ports of the NAS system must be linked to the same Cisco FEC-compatible switch.

IEEE 802.3ad

IEEE 802.3ad is a performance technology standard that increases a system's network throughput. IEEE 802.3ad is similar to the FEC standard developed by Cisco. However, whereas FEC works only with FEC-compatible Cisco switches, IEEE 802.3ad works with all switches that support IEEE 802.3ad. To use IEEE 802.3ad, the Ethernet ports of the NAS system must be linked to the same IEEE 802.3ad switch.

Creating Intel PROSet II Network Teams

1. Log in to the NAS Manager.

See "[Logging in to the NAS Manager](#)" in "NAS Manager."

2. Click **Maintenance**, and then click **Terminal Services**.
3. Log in to the Terminal Services session as administrator.

 **NOTE:** The default administrator user name is `administrator` and the default password is `powervault`.

4. Under **Administrative Tools** on the Advanced Administration Menu, click **Intel Network Teaming**.

 **NOTE:** If the Advanced Administration Menu does not display, double-click the **Advanced Administration Menu** icon on the desktop of the NAS system.

The Network Teaming utility, Intel PROSet II, displays.

5. Click **Action**, click **Add to Team**, and then click **Create New Team**.

The Teaming Wizard displays.

6. Select the type of team to create, and then click **Next**.

The types of team include **Adapter Fault Tolerance**, **Adaptive Load Balancing**, **Fast EtherChannel*/Link Aggregation**, and **IEEE 802.3ad**.

7. Select the Intel adapters to include with this team, and then click **Next**.

 **NOTE:** Broadcom NICs cannot be selected.

8. Verify that the team contains the appropriate members, and then click **Finish**.
9. If the team needs to be modified, click **Back**.

Removing Intel PROSet II Network Teams

1. Log in to the NAS Manager.

See "[Logging in to the NAS Manager](#)" in "NAS Manager."

2. Click **Maintenance**, and then click **Terminal Services**.
3. Log in to the Terminal Services session as administrator.

 **NOTE:** The default administrator user name is `administrator` and the default password is `powervault`.

4. Under **Administrative Tools** on the Advanced Administration Menu, click **Intel Network Teaming**.

 **NOTE:** If the Advanced Administration Menu does not display, double-click the **Advanced Administration Menu** icon on the desktop of the NAS system.

The Network Teaming utility, Intel PROSet II, displays.

5. In the tree view, click the team that you want to remove.
6. Click **Action**, and then click **Remove**.

Removing an Intel PROSet II Adapter From a Network Team

1. Log in to the NAS Manager.

See "[Logging in to the NAS Manager](#)" in "NAS Manager."

2. Click **Maintenance**, and then click **Terminal Services**.
3. Log in to the Terminal Services session as administrator.

 **NOTE:** The default administrator user name is `administrator` and the default password is `powervault`.

4. Under **Administrative Tools** on the Advanced Administration Menu, click **Intel Network Teaming**.

 **NOTE:** If the Advanced Administration Menu does not display, double-click the **Advanced Administration Menu** icon on the desktop of the NAS system.

The Network Teaming utility, Intel PROSet II, displays.

5. In the tree view, click the adapter that you want to remove.
6. Click **Action**, and then click **Remove**.

Changing the Intel PROSet II Network Team Mode

1. Log in to the NAS Manager.

See "[Logging in to the NAS Manager](#)" in "NAS Manager."

2. Click **Maintenance**, and then click **Terminal Services**.
3. Log in to the Terminal Services session as an administrator.

 **NOTE:** The default administrator user name is `administrator` and the default password is `powervault`.

4. Under **Administrative Tools** on the Advanced Administration Menu, click **Intel Network Teaming**.

 **NOTE:** If the Advanced Administration Menu does not display, double-click the **Advanced Administration Menu** icon on the desktop of the NAS system.

The Network Teaming utility, Intel PROSet II, displays.

5. In the tree view, click the team to modify.
6. Click **Action**, and then click **Change Team Mode**.
7. In the Teaming Wizard, select the type of team that you want to create, and then click **Next**.

The types of team include **Fault Tolerance**, **Load Balancing**, **Fast EtherChannel*/Link Aggregation**, and **IEEE 802.3ad**.

8. Click **OK** to close.

Creating Network Teams Using the Broadcom Advanced Server Control Suite

1. Log in to the NAS Manager.

See "[Logging in to the NAS Manager](#)" in "NAS Manager."

2. Click **Maintenance**, and then click **Terminal Services**.
3. Log in to the Terminal Services session as administrator.

 **NOTE:** The default administrator user name is `administrator` and the default password is `powervault`.

4. Under **Administrative Tools** on the Advanced Administration Menu, click **Broadcom Network Teaming**.

 **NOTE:** If the Advanced Administration Menu does not display, double-click the **Advanced Administration Menu** icon on the desktop of the NAS system.

The **Broadcom Advanced Server Control Suite** window displays.

5. Click **Load Balance/Virtual LAN**.
6. Click **Create Team**.
7. Enter the team name and select the appropriate team mode.

The types of team include **Start Load Balance and Fail Over**, **FEC/GEC**, and **Link Aggregation (IEEE 802.3ad)**.

8. Click **OK**.
9. Select the team name in the **Configuration** box.
10. Select an unassigned adapter to add to the team, and then click the arrow adjacent to the **Team Members** list to add the adapter.
11. Repeat step 10 for the second adapter.
12. Click **OK**.

Removing Broadcom Adapter From a Network Team

1. Log in to the NAS Manager.

See "[Logging in to the NAS Manager](#)" in "NAS Manager."

2. Click **Maintenance**, and then click **Terminal Services**.
3. Log in to the Terminal Services session as administrator.



NOTE: The default administrator user name is `administrator` and the default password is `powervault`.

4. Under **Administrative Tools** on the Advanced Administration Menu, click **Broadcom Network Teaming**.



NOTE: If the Advanced Administration Menu does not display, double-click the **Advanced Administration Menu** icon on the desktop of the NAS system.

The **Broadcom Advanced Server Control Suite** window displays.

5. Click **Load Balance/Virtual LAN**.
6. Select the team name in the **Configuration** box.
7. Select an adapter in the **Team Members** list, and then click the arrow adjacent to **Team Members** to remove the adapter.
8. Click **OK**.

Changing the Network Team Mode Using the Broadcom Advanced Server Control Suite

1. Log in to the NAS Manager.

See "[Logging in to the NAS Manager](#)" in "NAS Manager."

2. Click **Maintenance**, and then click **Terminal Services**.
3. Log in to the Terminal Services session as administrator.



NOTE: The default administrator user name is `administrator` and the default password is `powervault`.

4. Under **Administrative Tools** on the Advanced Administration Menu, click **Broadcom Network Teaming**.



NOTE: If the Advanced Administration Menu does not display, double-click the **Advanced Administration Menu** icon on the desktop of the NAS system.

The **Broadcom Advanced Server Control Suite** window displays.

5. Click **Load Balance/Virtual LAN**.
6. Select the team name in the **Configuration** box.
7. Select the new type of team and click **OK** to apply the change.

The types of team include **Start Load Balance and Fail Over**, **FEC/GEC**, and **Link Aggregation (IEEE 802.3ad)**.

Services for UNIX®

Services for UNIX (SFU) provides the tools needed to integrate UNIX and Windows networks by leveraging existing UNIX network resources and expertise. SFU includes more than 60 of the most common UNIX command line utilities to provide a familiar environment for UNIX users and administrators.

Server for NFS allows you to leverage your existing UNIX network resources for UNIX clients.

SFU provides important tools to enhance and simplify the administration of your network.

- Telnet Server enables character- and script-based remote administration of Windows 2000 and Windows NT®-based servers from a variety of clients.
- Microsoft Management Console (MMC) snap-in enables a consistent and central management point for all SFU functionality.
- ActivePerl enables existing and new scripts to use the Windows Management Interface (WMI) to automate network administration tasks.
- User Name Mapping associates Windows and UNIX user names, which allows users to connect to NFS resources without having to log in to UNIX systems separately.

Server for Network File System (NFS)

SFU provides a robust Server for NFS that can be used to provide disk resources from systems running Windows NT and Windows 2000 to any system on your network that supports NFS. To administer Server for NFS, set the following options from the SFU MMC console:

- **User Mapping** is the name of the mapping server to use.
- **Auditing** is the size and location of the logging file and the operations to audit.
- **Locking** is the grace period for locks and a list of current locks.
- **Client Groups** is used to group client systems for easier setting of permissions.

UNIX Utilities

[Table 7-2](#) lists UNIX utilities provided with SFU.

Table 7-2. Categories of UNIX Utilities

Category	Utility
File and directory utilities	basename, cp, diff, dirname, dos2unix, find, ln, ls, mkdir, mount, mv, paste, pwd, rm, rmdir, sdiff, split, tee, touch, uniq, uuencode, uumount
Text utilities	cat, cut, grep, egrep, fgrep, head, more, printf, sed, sort, tail, tr, vi, wc
Programming utilities	perl, od, sh, strings
Security utilities	chmod, chown, su
Process and general utilities	cron, crontab, date, du, kill, nice, printenv, ps, rcmd, renice, sleep, atr, top, uname, wait, which, xargs

Telnet Server

The Telnet server works optimally for most installations. It accepts logins from a variety of clients, including the Telnet clients shipped with Windows 2000, Windows NT, Windows 95, and Windows 98, as well as a variety of character mode terminal clients from virtually any operating system. In addition, it can be configured to meet specific site requirements such as improving security, simplifying logins, and supporting stream or console mode.

Authentication

The SFU Telnet server supports Windows NT LAN Manager (NTLM) for authentication of client logins. NTLM allows users to be automatically authenticated to the Telnet server based on their Windows NT login. This makes using Telnet completely transparent to users, while ensuring that clear text passwords do not pass over the network. However, NTLM must be supported on the client side of the login as well.

When users are logged in to a system that is using NTLM login, they are restricted to local drives on that system. If they need to map network resources, they can do so by explicitly mapping with full credentials.

Administration

The Telnet server is administered using the SFU MMC snap-in or the **tnadmin** program.

The following options are available:

- **Authentication** gives you the choice of **NTLM** or **Username/Password**.
- **Auditing** enables you to set event logging to a separate log file or to the event log and to specify what events to log.
- **Server Settings** enables you to set the following options:
 - Maximum number of simultaneous connections.
 - Maximum number of failed login attempts.
 - Map <Alt> key to <Ctrl><A>.
 - Telnet port.
 - **Console** or **Stream** for mode of operation.
 - **Default Domain Name** is the domain name that is automatically added to the login username. The default is ".", which disables this feature.
 - **Idle Session Timeout** is the time until an idle session is forcibly disconnected.
 - **Terminate all programs when disconnecting** or **Continue to run programs started with the command bgjob**.
- **Sessions** allows you to see data about the currently active sessions (such as user, domain, system, and logon date/time) and to either send a message to the session or terminate it.

Services for UNIX MMC Console

SFU UNIX includes a single MMC for managing all of SFU. The MMC provides a cohesive management interface that allows you to administer all systems on the network from any console. Further, since SFU supports the Windows Management Interface (WMI), management can be scripted from the command line.

You can access the MMC Console by selecting **Computer Management** under **System Management** on the Advanced Administration Menu. See "[Using the PowerVault Advanced Administration Menu](#)" in "NAS Manager."

ActiveState ActivePerl 5.6

SFU includes ActiveState's ActivePerl 5.6, a full-featured port of Perl 5.6 and Perl Script to Windows Powered operating systems. Among other improvements, ActivePerl 5.6 includes support for `fork()` emulation at the interpreter level, improving the portability of scripts and modules. ActivePerl also provides full support for the Windows Script Host, making

ActivePerl an excellent tool for system administration tasks.

User Name Mapping

User Name Mapping provides mapping of names between the UNIX and Windows environments. You can configure User Name Mapping from the SFU MMC Console or by using the NAS Manager to configure properties for the NFS Sharing Protocol. With User Name Mapping, you can create simple maps between Windows Powered user accounts and corresponding UNIX accounts. You can also use the Advanced Map feature to map accounts with dissimilar names. Given that UNIX user names are case-sensitive, while Windows Powered operating system names are not, the use of User Name Mapping can greatly simplify maintaining and managing accounts in the two environments. User Name Mapping uses Network Information Service (NIS) or local Personal Computer Network File System (PCNFS) user and group files to authenticate users. Also, User Name Mapping supports bidirectional one-to-many mapping, allowing you to map a single UNIX or Windows Powered operating system account to multiple accounts in the other environment. For example, you can map more than one administrative account in a Windows Powered operating system to the UNIX root account.

To create user and group name maps, perform the following steps:

1. Log in to the NAS Manager.

See "[Logging in to the NAS Manager](#)" in "NAS Manager."

2. From the NAS Manager, click **Shares**.
3. Click **Sharing Protocols**.
4. Click **NFS Protocol**, and then click **Properties**.
5. Click **User and Group Mappings**.
6. Use the **User and Group Mappings** window to define your user and group maps.

Configuration

To configure the type of server to be used to access UNIX user and group names, perform the following steps:

1. On the **User and Group Mappings** window, click **General**.
2. Click **Use NIS server**, or click **Use password and group files** to select the server type.
3. Depending on whether you use an NIS server or password and group files, perform one of the following steps:
 - For password and group files, specify the location and filename of the UNIX password file and UNIX group file.

 **NOTE:** The UNIX password file and group file formats must conform to the UNIX standard for these files.

- For NIS server, type the NIS domain and, optionally, the name of the NIS server.
4. Click **OK** to apply the configuration.

Defining Maps

To define simple maps in SFU, select the **Simple Maps** check box, and then perform the following steps:

1. In the **User and Group Mappings** window menu, click **Simple Mappings**.
2. Click **Enable Simple Mapping**.
3. Specify the **Windows Domain**.
4. Click **OK** to create the maps.

If you are defining explicit maps, you create user and group maps individually. To create explicit maps, perform the following steps:

1. On the **User and Group Mappings** window menu, click **Explicit User Mapping** to create user maps, or click **Explicit Group Mapping** to create group maps.
2. Specify the **Windows Domain**. If the server is configured as **PCNFS**, go to step 4.
3. Click **List UNIX Users** or **List UNIX Groups**.

This action refreshes your UNIX users or groups selection.

4. Create map entries by selecting a Windows user or group and a UNIX user (UID) or group (GID) from the list and clicking **Add**.
5. Click **OK** to create the maps.

Basic Scenarios

For UNIX and Windows NT User Name Mapping, an NIS Server must already exist in the UNIX environment or UNIX user and group files must exist on the PowerVault NAS system. User Name Mapping associates UNIX users and groups to Windows NT users and groups. You can use two types of maps, simple and explicit. Simple maps define a one-to-one relationship between the same user names and groups. Explicit maps define a relationship between dissimilar user names and groups.

Workgroup

In the workgroup scenario, you configure User Name Mapping locally on the PowerVault 715N system. All maps are contained on this system.

Domain

In the domain scenario, you configure NFS Authentication on all domain controllers. The NT Authentication Service installation program must be installed on the domain controller and available in the **DomainUtils** share on the NAS system.

To install the NT Authentication Service on a domain controller, perform the following steps:

1. Log in to the domain controller as an administrator.
2. Map the NAS system's **DomainUtils** share.
3. Run **sfucustom.msi**, which is located in the **Services for Unix** directory.

Filename Character Translation

Although Windows and UNIX file systems do not allow certain characters in filenames, the characters that are prohibited by each operating system are not the same. For example, a valid Windows filename can not contain a colon (:), but a UNIX filename can. If a UNIX user attempts to create a file in an NFS share and that file contains an illegal character in its name, the attempt will fail.

You can use filename character translation to replace characters that are not allowed in a file system by mapping them to characters that are valid. To enable filename character translation, create a text file that maps Windows to UNIX characters, and then modify the registry entry that specifies the path and name of the translation file.

The filename character translation text file is a list of mapped characters in the following format, such as the following:

```
0xnn : 0xnn [ ; comment ]
```

where *nn* is the hexadecimal value of the character

The entry for a map from the UNIX character ":" to the Windows character "-" in the filename character translation text is as follows:

```
0x3a : 0x2d ; Map ':' (0x3a) to '-' (0x2d)
```

To map the character combination "()" to the character "^", add the following entry:

```
0x28 0x29 : 0x5e ; Map '()' to '^'
```

To specify the path and name of the filename character translation text file for Server for NFS to use, modify the following registry key to contain the path and filename of the character translation file:

```
HKLM\SOFTWARE\Microsoft\Server for NFS\CurrentVersion\Mapping\CharacterTranslation
```

File Server for Macintosh

File Server for Macintosh (FSM) provides the tools needed to integrate Macintosh and Windows networks by leveraging existing Macintosh network resource and expertise. FSM is disabled by default on the NAS system. See "[Enabling the AppleTalk Protocol](#)" for information about enabling FSM.

Enabling the AppleTalk Protocol

The AppleTalk protocol is disabled on the NAS system by default. You must enable the AppleTalk protocol for Macintosh clients to access the NAS system.

To enable the AppleTalk protocol, perform the following steps:

1. Log in to the NAS Manager.

See "[Logging in to the NAS Manager](#)" in "NAS Manager."

2. Click **Shares**.
3. Click **Sharing** Protocols.
4. Click **AppleTalk Protocol**, and then click **Enable**.

Adapter Bindings

FSM can bind to only one network adapter. By default, it is bound to the embedded 10/100TX Network Adapter. To change the binding in systems with multiple network adapters, the AppleTalk protocol properties for the network adapter to be used by AppleTalk must be modified to accept inbound connections.

AppleTalk Protocol Adapter Binding

To modify the AppleTalk protocol adapter binding for filers with multiple network adapters, perform the following steps from the NAS Manager:

1. Log in to the NAS Manager.

See "[Logging in to the NAS Manager](#)" in "NAS Manager."

2. Click **Network**.
3. Click **Interfaces**.
4. Click the radio button next to an enabled adapter to bind the AppleTalk protocol.



NOTE: The AppleTalk protocol must bind to an adapter that is enabled, regardless of whether the File Server for Macintosh is disabled.

5. On the **Tasks** menu, click **AppleTalk**.
6. Click the check box next to **Enable inbound AppleTalk connections on this adapter**.
7. Optionally, if you use AppleTalk zones, select the appropriate zone in the drop-down box.
8. Click **OK**.

Microsoft UAM Volume

A user authentication map (UAM) is a software program that prompts users for an account name and password before they log in to a server. The Macintosh Chooser has a standard UAM built in that uses the clear-text password or Apple's RandNum Exchange method of security.

Microsoft Authentication offers an additional level of security because the password is used as a key to encrypt a random number. If the system administrator has determined that encryption is an important security measure, you may be asked to use Microsoft Authentication in addition to Microsoft UAM authentication.

Requirements

To use Microsoft UAM 5.01, you must have a Macintosh client running AppleShare Client 3.8 or newer or the Mac operating system (OS) 8.5 or newer operating system. If you do not meet the minimum requirements, the Microsoft UAM Installer installs the old Microsoft UAM 1.0 module. If you upgrade your system software, you need to run the Microsoft UAM Installer again.

Installing User Authentication

Log in to the Microsoft UAM Volume on the system to access the **MS UAM** file, and then drag this file to the **AppleShare Folder** in your **System** folder.

To access the Microsoft Authentication files on the system, perform the following steps:

1. Create a user with a password of less than eight characters.
 - a. Log in to the NAS Manager.

See "[Logging in to the NAS Manager](#)" in "NAS Manager."
 - b. Click **Users**.
 - c. Click **New**.
 - d. Complete the information in the **Create New User** window and click **OK**.

 **NOTE:** The password can be no longer than eight characters. Passwords longer than eight characters cannot be used when mapping an Apple share without a UAM.

2. Click **Chooser** on the **Macintosh Apple** menu.
3. Double-click the **AppleShare** icon, and then click the **AppleTalk** zone in which the system with Services for Macintosh resides.

Ask your system administrator if you are not sure of the zone.

4. Select the system from the list of file servers, and click **OK**.
5. Click **Registered User**.
6. Enter the user name and password you created in step 1, and then click **OK**.
7. Select the **Microsoft UAM Volume**, and then click **OK**.
8. Close the **Chooser** dialog box.

To install the authentication files on the Macintosh workstation, perform the following steps:

1. Double-click **Microsoft UAM Volume** on the Macintosh desktop.
2. Double-click the **Microsoft UAM Installer** file on the Microsoft UAM volume.
3. Click **Continue** in the **Installer Welcome** screen.

The installer reports whether the installation succeeded.

If the installation succeeded, Macintosh users of this workstation are offered Microsoft Authentication when they connect to the system.

Restarting Workstation Services

If File Services for Macintosh cannot establish communications to the local RPC service, you may need to restart the Workstation Service.

To restart the Workstation Service, perform the following steps:

1. Log in to the NAS Manager.

See "[Logging in to the NAS Manager](#)."

2. Click **Maintenance**, and then click **Terminal Services**.

3. Log in to the NAS system as an administrator.

 **NOTE:** The default administrative user name is `administrator` and the default password is `powervault`.

The Advanced Administration Menu displays. If it does not display, double-click the **Advanced Administration Menu** icon on the desktop of the NAS appliance.

4. Click **System Management**, and then click **Computer Management**.
 5. Click **Services and Application**.
 6. Double-click **Services**.
 7. Right-click **Workstation** in the **Services** window, and select **Restart**.
 8. Confirm that you want to restart the Workstation Services.
-

Services for Novell® NetWare®

Services for NetWare (SFN) are compatible with Novell NetWare Bindery service for authentication and file access using the internetwork packet exchange/sequenced packet exchange (IPX/SPX) network protocol. Services for NetWare are disabled by default. See "[Enabling Services For NetWare](#)."

Enabling Services For NetWare

The NetWare protocol is disabled on the NAS system by default. You must enable the NetWare protocol for NetWare clients to access the NAS system.

To enable the NetWare protocol, perform the following steps:

1. Log in to the NAS Manager.

See "[Logging in to the NAS Manager](#)" in "NAS Manager."

2. Click **Shares**.
3. Click **Sharing** Protocols.
4. Click **NetWare Protocol**, and then click **Enable**.

Configuring the NWLink IPX/SPX Compatible Protocol

To configure this protocol, you need the internal network number, the frame type, and the network number.

Internal Network Number

Internal network numbers are used for internal routing and are generally needed only for servers. You should not need to change this option on your system.

Frame Type and Network Number

Frame types define the packet formats that are used by different networks. It is important that all systems in a network have the same frame type so that they can communicate with the rest of the network.

When you are configuring your system, it attempts to automatically detect the frame type for the client. In most cases, this is successful. However, occasionally the automatic detection feature selects an inappropriate frame type, usually because more than one frame type exists on the network. If this happens, you should manually set the frame type to match the one specified on your NetWare server. Note that if more than one frame type exists, you should select the one that is detected first. For example, if the frame types Ethernet 802.2 and Ethernet 802.3 are bound to the same segment, then configure frame type Ethernet 802.2. The order of detection is Ethernet 802.2, Ethernet 802.3, Ethernet II, and then Ethernet SNAP.

Configuring the IPX Protocol

By default, the IPX protocol is configured on the NAS system to automatically detect frame types. To use the IPX protocol, you must change your NAS system's IPX properties to manually detect frame types.

To configure the IPX protocol to manually detect frame types, perform the following steps:

1. Log in to the NAS Manager.

See "[Logging in to the NAS Manager.](#)"

2. Click **Maintenance**, and then click **Terminal Services**.
3. Log in to the NAS system as an administrator.



NOTE: The default administrative user name is `administrator` and the default password is `powervault`.

The Advanced Administration Menu displays. If it does not display, double-click the **Advanced Administration Menu** icon on the desktop of the NAS appliance.

4. Click **System Management**, and then click **Network Properties**.
5. In the **Network and Dial-up Connections** window, right-click the network adapter used by the NAS system and select **Properties**.
6. In the **Local Area Connection** window, click **NWLink/IPX/NetBIOS Compatible Transport Protocol**, and click **Properties**.
7. In the **NWLink/IPX/NetBIOS Compatible Transport Protocol** window, select **Manual Frame type detection**.
8. Click **Add**.
9. In the **Manual Frame Detection** window, select a frame type and enter a network number for the IPX network.
10. Click **OK**.
11. Click **OK** to close the **Local Area Connection** window.
12. Click **OK** again to close the **Network and Dial-Up Connections** window.

The IPX protocol is now configured on the NAS system to manually detect frame types.

Microsoft Directory Synchronization Services

Microsoft Directory Synchronization Services (MSDSS) allows you to synchronize a wide variety of data stored in the Active Directory service with Novell Directory Service (NDS) and NetWare 3.x binderies.

MSDSS is a highly flexible service that helps Novell users to perform the following tasks:

- Adopt Windows 2000 Server and the Active Directory service
- Reduce directory management through two-way synchronization

- Migrate NDS and bindery information to Windows 2000 Server

MSDSS supports two-way synchronization with NDS and one-way synchronization with NetWare 3.x binderies to provide a complete directory interoperability solution. MSDSS also supports password synchronization and provides a directory migration service.

MSDSS allows NetWare users to deploy Active Directory without having to replace existing directories or bear the cost of managing two separate directories. As a result, users have the flexibility to:

- Consolidate directory management when multiple directories are required
- Manage accounts from either directory
- Use directory-enabled applications, devices, and services based on the Windows 2000 Active Directory service

MSDSS is easy to use and makes synchronization and Active Directory setup easy through its management interface. It is fully featured to allow users a choice of management, synchronization, and migration options.

MSDSS supports all major NetWare platforms and most Novell directories and binderies, and it includes support for IPX/SPX and TCP/IP network protocols.

Windows 2000 MSDSS Domain Controller

To implement MSDSS, you must install the Windows 2000 Server operating system and the MSDSS software (available on the *Microsoft Services for NetWare Version 5 CD*) on at least one system. In Windows 2000, when you promote a system running Windows 2000 Server to an Active Directory server, it becomes a domain controller. You use this domain controller to configure Active Directory, install MSDSS, and then import information from the existing NetWare environment.

The larger the environment, the more new servers you need. If you are planning to have more than one domain, then you need new hardware for the first domain controller in each domain.

You must also install Novell Client Access software on the MSDSS server or servers. MSDSS uses Novell Client Access to authenticate and to access NDS. While accessing NDS, it authenticates, but does not use a license. MSDSS also uses Novell Client Access to map one directory's contents to another, taking into account the fact that the object classes in Novell's NDS or bindery directories are different from Active Directory object classes. Novell Client Access is also required to use the File Migration utility to migrate files.

You can install Novell Client Access in four modes: **IP only**, **IPX only**, **IP and IPX combined**, and **IP with IPX Compatibility Mode**. Most NetWare environments still use IPX. MSDSS works in all the modes because it uses Novell Client Access to access the lower layers.

If you are migrating NDS, you can import the user and group information from one NDS server to the MSDSS server because you have one user database per tree. You can then migrate the file system. Remember that each Novell server has its own file system, which is not replicated to other servers (whereas NDS is replicated to other servers). After the files are migrated, you can uninstall NDS from the server to provide more space for the Windows 2000 Server operating system.

Outline of the Deployment Procedure

The next two sections describe the procedures for implementing MSDSS in a smaller (local area network [LAN] only) or larger (wide area network [WAN]) network. You need to adapt the guidelines to suit your environment and goals.

Small Environment

A small company with a LAN-based and uncomplicated network is often a likely candidate for a quick migration. After doing all the preparations described in the previous section, perform the following steps (adjusted, if necessary, to your situation):

1. Back up your NetWare system and user data.
2. Install and configure a Windows 2000 domain controller (see the documentation that came with your operating system software).
3. Install the Novell Client for Windows 2000 from the Novell website at www.novell.com/download.
4. Replace services or applications that require NDS with software that is compatible with Active Directory. (Remove NDS applications before you begin using MSDSS, except for ZENworks, which can be replaced by IntelliMirror at any

time.)

5. Install MSDSS from the system **DomainUtils** share.



NOTE: To access MSDSS software, map a network drive to **\\Dellxxxxxxx\DomainUtils**, where **xxxxxxx** is the system's service tag number. For example, if your service tag number is 1234567, type **DELL1234567**. You can find the service tag number on the top cover of your NAS system.

6. Log in to the NDS tree or bindery server as **administrator**.
7. Log in to the appropriate Windows 2000 domain as a member of the Domain Admins group.
8. On the MSDSS server, open the Help files, and then print out the procedures "To perform a one-time migration" and "To migrate files."
9. Click the **Start** button, and then point to **Programs® Administrative Tools® Directory Synchronization** to start MSDSS.
10. Follow the instructions as described in the Help printout, "To perform a one-time migration." The prompts guide you through the following steps:
 - a. Right-click **MSDSS** in the console tree, and then click **New Session** to start the New Session Wizard.
 - b. Specify whether objects are to be copied from NDS or Bindery.
 - c. Click **Migration**.
 - d. If you plan to migrate files as well as directory objects, click the **Migrate Files** check box.

You must also run the File Migration utility.

- e. Specify the path to the Active Directory container in which you want to copy items.
- f. Accept the default domain controller in which to store the migration log.
- g. Specify the NDS Container or Bindery Container from which to copy items.
- h. Provide the name and password of the Novell administrative account.
- i. On the **Initial Reverse Synchronization** page, specify the password options (such as **Set passwords to the user name.**)

When you are performing a migration, this page does not include the option to actually perform an initial reverse synchronization, but it is the page where you specify which password option you want to use.

- j. Set **synchronization mode** to **default object mapping** or to **custom object mapping**.
- k. If you selected **custom object mapping**, you are prompted to manually establish one-to-one relationships between pairs of objects.
- l. Click **Finish**.

After the user accounts are migrated, you can migrate the file system (migrating the users before the files allows you to migrate file-system permissions). Follow the instructions in the Help printout, "To migrate files." The prompts guide you through the following steps:

- To start the File Migration Utility, click the **Start** button and point to **Programs® Administrative Tools® File Migration Utility**.
- To view mapping relationships, click **View Maps**.
- To view mapped access rights for the users, groups, organization units, and organizations to be migrated, click **Access Rights**.

The **NDS Modify** option converts, by default, to **Read** because it does not have an equivalent NDFS right. You might want to click the **Write** check box to allow read/write access.

- On the **Step 2 — Security Accounts** tab, verify that you are logged on with the correct Active Directory, NDS, or Bindery credentials.

- On the **Step 3 — Source and Target** tab under **Source (NDS/Bindery)**, click the volume or directories from which you want to migrate files. Under **Target (Active Directory)**, click the shares or directories to which you want to migrate files, click the **Map** button, and then click **Next**.

If the NDS or Bindery volume you selected in the source tree displays **Unavailable**, then you are not currently logged in to that tree or Bindery server. Log in, and then press <F5> after reselecting the volume to view the directories within the displayed volume.

- On the **Step 4 — Log File** tab, select your logging options, and then click **Next**.
- On the **Step 5 — Scan** tab, click **Scan**, and then click **Next**.

The utility scans all source volumes and counts and displays the number of directories and files in each. It ensures that proper access has been given to each source volume, directory, and file. If any errors occur, the utility displays them under **NetWare scan logs** and **Windows scan logs**, respectively. You can select a number of acceptable errors; if this number is exceeded, the process aborts, allowing you to return to previous steps to correct the errors.

- On the **Step 6 — Migrate** tab, click **Migrate**.

Manually migrate (or use third-party utilities to migrate) object security permissions and system accounts, printer objects, application objects, and other objects that MSDSS does not migrate from Bindery or NDS to Active Directory. (MSDSS migrates NetWare user accounts, groups, and distribution lists for Bindery and NDS, and, for NDS only, MSDSS also migrates NDS organizational units and organizations.)

1. Upgrade your NetWare server(s) to the Windows 2000 Server or Professional operating system.
2. On each Windows desktop in your NetWare network, uninstall Novell Client Access.

You must configure the desktops to join the Windows 2000 domain.

3. Optionally, upgrade NetWare clients (workstations) to the Windows 2000 Professional operating system.
4. Configure all client systems (both Windows and non-Windows), to join the Windows 2000 domain.

Be sure that the users know how to handle their password the first time they log in (for possible password options, see "MSDSS Password Management" in "MSDSS Deployment: Understanding Synchronization and Migration") at www.microsoft.com.

Medium-Sized or Large Environment

An organization large enough to have WAN links probably selects to synchronize its networks temporarily while performing a gradual migration over time (up to 3 months for a large network), or it prefers to use synchronization to establish a mixed Novell/Windows 2000 network on a long-term basis. If you plan a staged migration, one-way synchronization is often the appropriate choice.

After doing all the preparation described above, perform the following steps (adjusted, if necessary, to your situation):

1. Back up your NetWare user and system data.
2. Install and configure a Windows 2000 domain controller (see the documentation that came with your operating system software).
3. Install the Novell Client for Windows 2000 from the Novell website at www.novell.com/download.
4. Install MSDSS from the PowerVault 715N system **DomainUtils** share.

 **NOTE:** To access MSDSS software, map a network drive to `\\Dellxxxxxxx\DomainUtils`, where `xxxxxxx` is the system's service tag number. For example, if your service tag number is 1234567, type `DELL1234567`. You can find the service tag number on the top cover of your NAS system.

5. Log in to the NDS tree or Bindery server with administrative credentials.
6. Log in to the appropriate Windows 2000 domain as a member of the Domain Admins group.
7. On the MSDSS server, open the Help files, and then print out the steps (briefly summarized below) for "To perform a one-way synchronization" or "To perform a two-way synchronization."

8. Click the **Start** button, point to **Programs® Administrative Tools® Directory Synchronization** to start MSDSS, and then allow the prompts to guide you through the following tasks:
 - a. Start the New Session Wizard (right-click **MSDSS** in the console tree).
 - b. Select **Novell Bindery** or **Novell Directory Services (NDS)** for one-way synchronization, or select **Novell Directory Services (NDS)** for two-way synchronization.
 - c. Select **One-way synchronization (from Active Directory to NDS or Bindery)** or select **Two-way synchronization (from Active Directory to NDS and back)**.
 - d. Specify the path to the **Active Directory** container into which you want to copy items.
 - e. Accept the default domain controller in which to store the session database.
 - f. Specify the NDS Container or Bindery Container from which to copy items.
 - g. Provide the name and password of the Novell administrative account.
 - h. On the **Initial Reverse Synchronization** page, select **Perform an initial reverse synchronization**.
 - i. Still on the **Initial Reverse Synchronization** page, specify the password options (such as **Set passwords to the user name**).
 - j. On the **Object Mapping Scheme** page, click **Default** (to accept the default mapping for each source and target directory pair) or **Custom** (for NDS only), and then click **Object Mapping Table** (to specify objects for which you want to establish a one-to-one relationship, regardless of the object location in either directory tree).

MSDSS does not support custom object mapping for Bindery.
 - k. Still on the **Object Mapping Scheme** page, click **Filters** if you want to configure a filter for this synchronization session.
 - l. On the **Session Name** page, accept the default session name or specify a new name.
 - m. Click **Finish**.
9. If you selected one-way synchronization, you should now perform all user, group, and NDS organizational unit (OU) object management from Active Directory. If you established two-way synchronization, you can now manage user, group, and OU objects from either Active Directory or NDS.
10. If you plan long-term coexistence between Active Directory and NetWare, you are now finished, unless you want to migrate a subset of users, systems, and/or files. If you plan to continue by migrating in stages from NetWare to Active Directory, perform the following tasks in the time-frame that is convenient for you:
 - Install and configure File and Print Services for NetWare (to allow NetWare clients access to files and printers on Windows 2000 servers) and Gateway Services for NetWare (to allow Windows clients access files and printers on NetWare servers).
 - Replace services or applications that require NDS with commensurate software compatible with Active Directory. Perform large conversions (such as GroupWise to Exchange) as separate projects.
 - Migrate the pilot group of users and their files (adapt instructions from the migration steps provided in the "[Small Environment](#)" section). Get the pilot group's feedback, and then set a schedule to migrate additional groups of users, according to the priorities you have established.
 - Migrate the rest of the users as appropriate (for example, if you migrate the set of applications they use, it is time to migrate them as well).

For more information, see the Novell website at support.novell.com/servlet/Knowledgebase and the Windows 2000 website at www.microsoft.com/windows2000.

Using Secure Sockets Layers

This section explains how secure sockets layers (SSL) are used in the NAS system. It also explains how to use your own certificate, if you have one, and how to regenerate your certificate.

Introduction to SSL Certificates

Certificates contain information that is used to establish system identities over a network. This identification process is called authentication. Although authentication is similar to conventional forms of identification, certificates enable Web servers and users to authenticate each other before establishing a connection to create more secure communications. Certificates also contain encryption values, or keys, that are used in establishing an SSL connection between the client and server. Information, such as a credit card number, sent over this connection is encrypted so that it cannot be intercepted and used by unauthorized parties.

Two types of certificates are used in SSL. Each type has its own format and purpose. *Client certificates* contain personal information about the clients requesting access to your site, which allows you to positively identify them before allowing them access to the site. *Server certificates* contain information about the server, which allows the client to positively identify the server before sharing sensitive information.

Server Certificates

To activate your Web server's SSL 3.0 security features, you must obtain and install a valid server certificate. Server certificates are digital identifications containing information about your Web server and the organization sponsoring the server's Web content. A server certificate enables users to authenticate your server, check the validity of Web content, and establish a secure connection. The server certificate also contains a *public key*, which is used in creating a secure connection between the client and server.

The success of a server certificate as a means of identification depends on whether the user trusts the validity of information contained in the certificate. For example, a user logging on to your company's website might be hesitant to provide credit card information, despite having viewed the contents of your company's server certificate. This might be especially true if your company is new and not well known.

For this reason, certificates are sometimes issued and endorsed by a mutually trusted, third-party organization, called a certification authority. The certification authority's primary responsibility is confirming the identity of those seeking a certificate, thus ensuring the validity of the identification information contained in the certificate.

Alternatively, depending on your organization's relationship with its website users, you can issue your own server certificates. For example, in the case of a large corporate intranet handling employee payroll and benefits information, corporate management might decide to maintain a certificate server and assume responsibility for validating identification information and issuing server certificates. For more information, see "[Obtaining a Server Certificate From a Certification Authority](#)."

PowerVault 715N Certificate

By default, the PowerVault 715N has a self-generated and self-signed certificate. The configured SSL port is 1279.



NOTE: For non-SSL communication, use port 1278. This port is not a secure port and all text is sent in plain text over the network.

Using a Custom Certificate

If a certification authority is present in the network, the administrator can choose to change the default PowerVault 715N certificate. The administrator must use the wizards to first request a certificate and then apply it to the NAS system.

Obtaining a Server Certificate From a Certification Authority



NOTE: If you are replacing your current server certificate, the Internet Information Server (IIS) continues to use the old certificate until the new request has been completed.

Find a certification authority that provides services that meet your business needs, and then request a server certificate.



NOTE: For the latest list of certification authorities supporting IIS, see the Microsoft Security website. In the **By Category** list, select **Certification Authority Services**.

To obtain a server certificate, perform the following steps:

1. Log in to the NAS Manager.

See "[Logging in to the NAS Manager](#)."

2. Click **Maintenance**, and then click **Terminal Services**.
3. Log in to the NAS system as an administrator.

 **NOTE:** The default administrative user name is `administrator` and the default password is `powervault`.

The Advanced Administration Menu displays. If it does not display, double-click the **Advanced Administration Menu** icon on the desktop of the NAS appliance.

4. Click **System Management**, and then from the list, click **Internet Information Services**.
5. Navigate to and right-click the **Administration site** section, and then select **Properties**.
6. Under **Secure Communications** on the **Directory Security** property sheet, click **Server Certificate** to access the Web Server Certificate Wizard.
7. Use the Web Server Certificate Wizard to create a certificate request.
8. Send the certificate request to the certification authority.

The certification authority processes the request and sends you the certificate.

 **NOTE:** Some certification authorities require you to prove your identity before processing your request or issuing you a certificate.

9. Use the Web Server Certificate Wizard to install your certificate.

For more information about SSL, see the Internet Information Server online help.

SNMP Considerations

Your NAS system uses the simple network management protocol (SNMP), which is a set of protocols used by systems to provide information to a central management information database. The NAS Manager provides a method for configuring the community and agent properties.

Configuring SNMP Community Properties

1. Log in to the NAS Manager.

See "[Logging in to the NAS Manager](#)" in "NAS Manager."

2. Click **Maintenance**, and then click **Terminal Services**.
3. Log in to the Terminal Services session as administrator.

 **NOTE:** The default administrator user name is `administrator` and the default password is `powervault`.

4. From the Advanced Administration Menu, select **System Management**, and click **Computer Management**.

 **NOTE:** If the Advanced Administration Menu does not display, double-click the **Advanced Administration Menu** icon on the desktop of the NAS system.

5. From the **Computer Management** console tree, click **Services and Applications**.
6. Click **Services**.
7. In the details pane, right-click **SNMP Service**.
8. From the **Action** menu, click **Properties**.
9. From the **Security** tab, click **Send authentication trap**.

Select this option if you want a trap message sent when authentication fails.

10. Select **Accepted community names**, and click **Add**.
11. Select **Community Rights**, and select a permission level for this host to process SNMP requests from the selected community.
12. To view a description of a dialog box item, right-click the item, and then click **What's This?**
13. In **Community Name**, type a case-sensitive community name, and then click **Add**.
14. In **SNMP Service Properties**, specify whether to accept SNMP packets from a host:
 - To accept SNMP requests from any host on the network, regardless of identity, click **Accept SNMP packets from any host**.
 - To limit acceptance of SNMP packets, click **Accept SNMP packets from these hosts**, click **Add**, type the appropriate host name, IP and/or IPX address, and then click **Add** again.

 **NOTE:** You can make changes to an entry by clicking the entry and then clicking **Edit**. You can delete a selected entry by clicking **Remove**.

 **NOTE:** If you remove all the community names, including the default name `Public`, SNMP does not respond to any community names presented. You can add additional community and host names as necessary.

 **NOTE:** If you change existing SNMP settings, your changes take effect immediately. You do not need to restart the SNMP service for your settings to take effect. If you are configuring SNMP for the first time, you must restart SNMP before the settings take effect.

Configuring SNMP Agent Properties

1. Log in to the NAS Manager.

See "[Logging in to the NAS Manager](#)" in "NAS Manager."

2. Click **Maintenance**.
3. Click **Terminal Services**.
4. Log in to the Terminal Services session.
5. Click **Advanced Administration Menu**.
6. In the Advanced Administration Menu, select **System Management**, and click **Computer Management**.
7. Click **Services and Applications**.
8. Click **Services**.
9. In the details pane, right-click **SNMP Service**.
10. From the **Action** menu, click **Properties**.
11. Select the **Agent** tab, select **Contact**, and type the name of the user or system administrator.
12. Select **Location**, and then type the physical location of the system or the contact.
13. In the **Service** panel, select the appropriate check boxes for this system, and then click **OK**.
14. To view a description of a dialog box item, right-click the item, and then click **What's This?**

 **NOTE:** If you change existing SNMP settings, your changes take effect immediately. You do not need to restart the SNMP service for your settings to take effect. If you are configuring SNMP for the first time, you must restart SNMP before the settings take effect.

Troubleshooting

Dell™ PowerVault™ 715N NAS Systems Administrator's Guide

[Tools and Techniques](#)

[Troubleshooting](#)

Tools and Techniques

Because the Dell™ PowerVault™ 715N NAS system is a "headless" system that does not have a keyboard, mouse, or monitor, you must use other methods for troubleshooting issues and conditions. This section provides suggestions for and information about alternative troubleshooting tools and techniques.

Console Redirection

Console redirection allows you to directly attach a client system to the NAS system for local management and troubleshooting. For more information about console redirection, see "[Using Console Redirection](#)" in "Advanced Features."

Serial Connection

You can directly attach a client system to your NAS system using a serial cable and the administration port to configure or troubleshoot your NAS system. For more information about using a serial connection, see the serial connection information for your operating system in "[Configuring the NAS System for the First Time](#)" in "Initial Configuration."

Ping Your NAS System

If you are unable to connect to the NAS system using the NAS Manager, try to ping the NAS system. From a client system, click the **Start** button, click **Run**, and then type `cmd`. At the command prompt in the `cmd.exe` window, type `ping system_name`, and then press <Enter>.



NOTE: The default system name is `DELLxxxxxxx`, where `xxxxxxx` is the system's service tag number. For example, if your service tag number is 1234567, type `DELL1234567`. You can find the service tag number on the top cover of your NAS system.

If you can ping the NAS system but cannot access it through the NAS Manager, your NAS system might still be booting into Microsoft® Windows® and might not have started the Microsoft Internet Information Services (IIS).



NOTE: The NAS system takes approximately 5 minutes to boot.

My Network Places

If you have a Windows 2000 client system on the same subnet as the NAS system, double-click **My Network Places**. Browse through the network and locate your NAS system.

System LEDs and Beep Codes

If your NAS system is not booting or responding properly, you can diagnose some problems using the system's LEDs and beep codes. For more information about the LEDs and beep codes, see your system's *Installation and Troubleshooting Guide*.

Terminal Services

You can use the Terminal Services Advanced Client to connect to your NAS system from a client system. You can access Terminal Services Client through the NAS Manager or the **Start** menu.

To access Terminal Services from the NAS Manager, perform the following steps:

1. Log in to the NAS Manager.

See "[Logging in to the NAS Manager](#)" in "NAS Manager."

2. Click **Maintenance**.

3. Click **Terminal Services**.

4. Enter the administrator user name and password and click **OK**.

 **NOTE:** The default administrator user name is administrator and the default password is powervault.

Troubleshooting

Use the following tables to help you troubleshoot various conditions that might occur on your NAS system:

- [Table 8-1](#), "General Troubleshooting"
- [Table 8-2](#), "NAS Manager"
- [Table 8-3](#), "Reinstallation"
- [Table 8-4](#), "Dell ActiveArchive"
- [Table 8-5](#), "Dell OpenManager Array Manager"
- [Table 8-6](#), "UNIX and Red Hat Linux"
- [Table 8-7](#), "Macintosh and AppleTalk"
- [Table 8-8](#), "Netscape Navigator"

Table 8-1. General Troubleshooting

Issue	Possible Cause	Resolution
I just created a new volume on my system but cannot see the volume on Windows Explorer through Terminal Services.	Terminal Services cannot update to show a new volume during the session in which it was created.	Log off Terminal Services. When you reconnect to Terminal Services, the volume should be visible.
I see the following error message in the event log: WMI ADAP was unable to load the winspool.drv performance library due to an unknown problem within the library: 0x0	This is an issue with the WDAP Performance library and is documented on Microsoft's website.	Connect to the system via Terminal Services Advanced Client, and then open a local command prompt. Type the following command: WINMGMT/CLEARADAP. When the prompt returns, type WINMGMT/RESYNCPERF winmgmt service PID.
I have just brought up my new NAS system on the network, but I am unable to upload files using FTP even though I am the administrator.	By default, no user has write privileges on the default FTP site.	The FTP permissions must be configured using the Microsoft Management Console (MMC). To access the MMC, click Computer Management on the Advanced Administration Menu, which is available through Terminal Services. See the online help for specific information about configuring this service.
I have deleted an FTP share and folder from my NAS system. However, when I use Terminal Services to confirm the removal, I can still see the shared folder in the FTP section of the MMC.	By default, this folder is not deleted by the PowerVault NAS Manager.	Manually remove this listing from the listed shared folders in the FTP section of the MMC.
The BIOS does not see hard drive 0.	The hard drive has failed or the operating system files or boot record is missing or corrupt.	No immediate action is required. The NAS system can automatically boot from hard drive 1.
When I turned on the NAS	During an unexpected shutdown and	Take no action. Your NAS system is

<p>system and it came back up, I had to wait to access it. The system appeared to regenerate the RAID 5 and RAID 1 volumes.</p>	<p>reboot, the NAS system cannot tell whether one or more write failures occurred. Therefore, following the reboot, the NAS system rebuilds all volumes and regenerates parity to make sure the files are consistent.</p>	<p>functioning as designed. The RAID rebuild takes several hours.</p>
<p>I inserted four new hard drives in the NAS system and then reinstalled the operating system. The NAS system is up and running, and the LEDs are showing activity on the system. However, the NAS system is not displayed in the Kick-Start utility window.</p>	<p>You tried to connect to the NAS system before the reinstallation was complete. The last step of the reinstallation process is to create the recovery partition and the data volume as RAID 5. The system is not displayed in the Kick-Start utility window until the RAID 5 synchronization is complete.</p>	<p>Wait until the RAID 5 synchronization is complete and the NAS system has shut down. This can take several hours.</p>
<p>I cannot connect to or ping the NAS system after turning it on.</p>	<p>The NAS system has not finished booting.</p>	<p>Wait at least 5 minutes for the NAS system to finish booting. If you still cannot connect, attempt the procedures in "Solutions to Try Before Reinstalling" in "Recovering and Restoring the System."</p>
<p>After using Terminal Services to connect to my NAS system, I am unable to type using my native language.</p>	<p>The NAS system is set to English, the default language.</p>	<p>You can install your native language character set from the <i>Multilingual Support</i> CD that was shipped with your system. For installation instructions, see "Advanced Features."</p>
<p>I cannot get console redirection to work correctly. Only a few keys work on the keyboard, and none of the keys work when trying to configure the BIOS.</p>	<p><Scroll Lock>, <Caps Lock>, or <Num Lock> might be set on your keyboard. Also, your operating system may not support all of the keys on your keyboard.</p>	<p>Ensure that the <Scroll Lock>, <Caps Lock>, and <Num Lock> lights are turned off on the keyboard. If these lights are not on and the problem persists, see "Console Redirection Keys" in "Advanced Features."</p>
<p>During a Terminal Services session to the NAS system, I mapped a network share from the NAS system. Now the system does not reboot correctly and hangs during shutdown.</p>	<p>Having a share mapped from the NAS system causes the system to hang during shutdown.</p>	<p>Make sure that when you map a share, you do not select Reconnect at logon. To disconnect the drive, right-click My Appliance on the NAS system desktop, and select Disconnect Network Drive. Click the CD share in the Disconnect Network Drive window, and then click OK.</p> <p>If you cannot log in to the NAS system, press the power button for less than 2 seconds to reboot. Then connect using Terminal Services and disconnecting the drive. If Terminal Services does not work, try connecting using a serial connection. See "Configuring Your System Using a Serial Connection" in "Initial Configuration."</p>
<p>My NAS system's event log displays the following event: The driver has detected that device \Device\Scsi\Ultra has old or out-of-date firmware. Reduced performance may result.</p>	<p>Under certain conditions, the IDE controller operating system drivers erroneously detect that its firmware is out of date.</p>	<p>No action required. The NAS system is operating normally.</p>
<p>The Telnet option in the NAS Manager does not allow me to enable Telnet on the NAS system, even though I have selected the check box next to Enable Telnet access to this NAS system on the Telnet Administration Configuration page.</p>	<p>This option is not enabled.</p>	<p>To enable Telnet on your NAS system, perform the following steps:</p> <ol style="list-style-type: none"> 1. From the NAS Manager primary menu, click Maintenance® Terminal Services. 2. Log in to the NAS system as an administrator. 3. If the Advanced Administration Menu is displayed, click Exit to close it. 4. Right-click My Appliance. 5. Click Manage. 6. Double-click Services and Applications® Services. 7. Locate and right-click Telnet, and

		then click Start . Telnet starts on the NAS system.
I cannot connect to the NAS system using the IPX protocol.	IPX networks require that you assign an IPX network number to all clients. By default, the NAS system does not assign an IPX number to the network.	Change the IPX protocol on the NAS system to manually detect frame types. See " Configuring the IPX Protocol " in "Advanced Features."
When viewing the POST through a HyperTerminal session to my NAS system, I see that the Ultra-100 Promise Controller displays hard drives D1 and D3 as Not Detected .	The NAS system is correctly detecting that only two hard drives are connected to the Ultra-100 Promise Controller. The other two hard drives in the system are connected to the VT82C686B controller.	No action is required. The NAS system is functioning as designed.
I am trying to install the CA ARCserve Remote Agent on the NAS system by mounting the CD share that contains the CA ARCserve CD. However, I am having trouble installing the program.	The CA installer does not work properly when installing from a CD share mounted on your NAS system.	To install the CA ARCserve Remote Agent, copy the CD contents to drive C of your NAS system. Then run the installer from the NAS system.
After restoring files from a backup, the modified dates of folders are inconsistent.	The modified dates of folders reflect either the date you performed the restore or the date the folder was modified.	Take no action. This is a design issue that occurs only with folders; the files' modified dates are consistent.
I performed a hard shutdown of the NAS system (by holding down the power button for longer than 3 seconds), and it took a long time to reboot.	When you perform a hard shutdown, the NAS system automatically rebuilds its RAID arrays the next time you boot.	Wait until the rebuild is complete. When powering off your NAS system, press the button for less than 3 seconds.
The Advanced Administration Menu does not display anymore.	You were not logged off of Terminal Services before you closed the NAS Manager.	Log off Terminal Services by clicking the Start button on the NAS system and logging off.

Table 8-2. NAS Manager

Issue	Possible Cause	Resolution
I am trying to select the Administer My Appliance link on the opening page of the PowerVault NAS Manager, but the link does not function properly.	The user account that you used to log in to the domain does not have administrator privileges. The link does not work for users without administrator privileges.	Type the address of the PowerVault NAS Manager in your browser. For SSL connections, type: <code>https://servername:1279</code> or <code>https://IPaddress:1279</code> For non-SSL connections, type: <code>http://servername:1278</code> or <code>http://IPaddress:1278</code>
I have just deleted a volume, and now I am unable to view my shares in the PowerVault NAS Manager.	In the event that a volume with shares is deleted, the PowerVault NAS Manager cannot display any shares until the shares that were directed to the deleted volume are removed.	Use Terminal Services Advanced Client to remove the shares for the deleted volume. Exit the PowerVault NAS Manager, and restart the system. The shares should now be visible.
I have just added an HTTP share but cannot see it from PowerVault NAS Manager.	For security purposes, directory browsing is not enabled by default on an HTTP share directed to the same folder or volume as another share.	To enable directory sharing for an HTTP share, from the PowerVault NAS Manager Maintenance page, click Terminal Services Advanced Client , and then modify the Web sharing properties of the folder.
I have just changed the IP address of my system, and now I cannot administer it through the PowerVault NAS Manager.	Although the IP address changed, your local host is still trying to communicate with the system using the old IP address. It takes approximately 15 minutes for the IP address to automatically update on most networks.	Close Microsoft Internet Explorer (or for Red Hat Linux only, Netscape Navigator 6.1 or later). Reconnect using the newly created IP address. Type: <code>https://IPaddress:1279</code> . It takes approximately 15 minutes for the DNS server to recognize the new IP address.
In the PowerVault NAS Manager, if I click OK and then click Cancel , it doesn't seem to cancel the	Cancel does not dynamically stop an update to the system after you click OK .	If an operation has been performed in error, the system administrator must change the setting back manually.

operation.		
When I select the Check All box and then deselect one or more choices on some screens in the PowerVault NAS Manager, the Check All box remains selected.	The Check All box is not automatically deselected. However, this does not mean that all items in the list are selected.	This behavior does not affect functionality. The Check All box does not indicate what has specifically been selected or deselected.
I have changed the password for the administrator account; however, several minutes have passed and I have not been queried for the new password.	The PowerVault NAS Manager does not automatically refresh the account information for the administrator while in the PowerVault NAS Manager. Instead, it performs the refresh as a timed function.	The password was successfully changed. If you want to confirm that the new password is in effect, close the browser, and then reconnect. The new password should work, but the old one should not.
I am looking for a topic on the context-sensitive online help in the PowerVault NAS Manager, but it says No Topic Available.	Some sections of the PowerVault NAS Manager do not have context-sensitive help.	For information on a specific function, see the Windows Powered Help, which is available through Terminal Services by clicking Windows Powered Help on the Advanced Administration Menu, or see the appropriate section in this <i>Administrator's Guide</i> .
I tried to clear the FTP log or the Web (HTTP) Shares log in the Maintenance section of the PowerVault NAS Manager, but I received an error message and the log was not cleared.	The logs are currently locked by the NAS system for the FTP service and to support the PowerVault NAS Manager. The logs cannot be cleared in the PowerVault NAS Manager.	Connect to the NAS system using Terminal Services and clear these logs by using MMC. You can access MMC by clicking Computer Management on the Advanced Administration Menu, which is available through Terminal Services.
While viewing the properties of a user, I selected the General tab. The fields for this user are now all blank.	You were already on the General tab and the page did not refresh properly.	Select Cancel or click Back on your browser. Then reselect the user for whom you wanted to view properties.
I added members to a local group using the PowerVault NAS Manager, but when I click OK , the screen only refreshes.	You might have removed and then added the same member to the local group. This may cause the screen to refresh instead of update correctly.	Reselect the Local Groups tab in the PowerVault NAS Manager primary menu. Then add or remove the appropriate members to or from the local group.
I cannot change the WINS addresses when I click Network on the NAS Manager primary menu, click Network Interfaces , and then click WINS in the Tasks list.	The NAS Manager grays out the WINS Servers Configuration page unless you set the IP Address Configuration page to Use the following IP settings .	To set the WINS addresses from the NAS Manager, click Network on the primary menu, click Interfaces , and click IP in the Tasks list. On the IP Address Configuration page, click the radio button for Use the following IP settings , and then type the IP address, Subnet mask, and the default gateway in the appropriate text boxes.
I can see only the first 100 items in the NAS Manager.	The NAS Manager displays only 100 items per page. For example, if you have 500 shares, the shares page will display only shares 1–100.	To display items beyond 100, click on the up or down arrows at the top of the table.

Table 8-3. Reinstallation

Issue	Possible cause	Resolution
When reinstalling the operating system, the NAS system exits without getting an IP address.	The Kick-Start utility DHCP option might not be enabled.	Ensure that the Kick-Start utility DHCP option is enabled.
During the reinstallation process, console redirection shows that the NAS system gets an IP address and then displays MTFTP 224.0.1.2 followed by BD. . . .	The PXE service could not be contacted.	Stop and then restart the PXE service.
I am reinstalling the operating system by following the procedure in " Reinstalling the Operating System " and console redirection displays the following message after I reboot the system: Unable to map share 'SHARE' with account 'USER' and password 'PASSWD.' Software installation aborted!	The share (typically \\PV715REC\CD) on your Windows 2000 client cannot	Ensure that the system and share described in the error message are available. Make sure that you can access the

.	be mapped from the NAS system.	share by using the user name and password provided.
I am reinstalling the operating system by following the procedure in " Reinstalling the Operating System " and Console redirection displays the following message after I reboot the system: Unable to find file 'pv715rec.nas' Make sure that the Dell PowerVault 715N ReInstallation CD is shared correctly. Software installation aborted!	The <i>Reinstallation</i> CD might not be available or shared correctly on the client system.	Ensure that the <i>Reinstallation</i> CD is inserted into the client system's CD drive and that the CD drive is shared on the network.

Table 8-4. Dell ActiveArchive™

Issue	Possible cause	Resolution
I cannot access my Dell ActiveArchive persistent images from a UNIX® Network File System (NFS) or Macintosh client.	Only Microsoft Windows (CIFS) clients can access the persistent images stored in the ActiveArchive folders for each volume.	Access the ActiveArchive folders through the Windows client to perform data recovery.
The XCOPY command does not copy my persistent images.	XCOPY cannot read the persistent images on a volume.	Do not use XCOPY to copy persistent images. Copy the files manually in Windows Explorer.
After I take a new persistent image, the definition of the persistent image is blank, or the persistent image does not show at all in the persistent images list.	The NAS Manager must complete a refresh cycle before it can correctly show the persistent image.	If this is the first persistent image, wait several minutes and check again. If this is a subsequent persistent image, wait for the NAS Manager to complete a refresh or press <F5>.
When I click Restore Defaults on the Global Settings page in Dell ActiveArchive after taking a persistent image, it changes my cache file size and the area is grayed out.	After you take a persistent image, you cannot change the cache file size; therefore, clicking Restore Defaults does not change the cache file size. To verify the cache file size, look at the cache file size on the Volume Settings page. You should see that it has reverted back to the original cache file size that you set before taking a persistent image.	Take no action. Dell ActiveArchive is functioning as designed.
I get a permission error when I try to access my persistent images from an HTTP or FTP share.	Accessing the persistent image directory through HTTP or FTP is not supported.	If you need to access your persistent image directory, connect to the system through a Terminal Services Advanced Client session and use Windows Explorer in the NAS system to access them.
When the maximum number of persistent images (250 by default) has been reached and I continue to take more of them, lower-priority persistent images are overwriting the existing higher-priority persistent images.	If a persistent image is taken manually or by schedule, Dell ActiveArchive takes the persistent image even if the maximum number of persistent images has been reached. Therefore, the new persistent image must overwrite an existing persistent image. By design, the new persistent image writes over the oldest, lowest-priority persistent image available, even if it is a higher-priority persistent image than the one currently being taken.	Take no action. Dell ActiveArchive is functioning as designed.
I cannot take a persistent image of drive C or D.	A persistent image cannot be taken of drive C or D.	Taking a persistent image of drive C or D is not supported.
I noticed that the date and time for the ActiveArchive directory changes every time I reboot my NAS system.	The ActiveArchive directory date and time are reset at each reboot. The new dates and times do not change the dates and times of your persistent images.	Take no action. This is the normal functionality of Dell ActiveArchive.
I have deleted a persistent image, but when the Persistent Images page redisplay I can still see the persistent image. If I try to	In some environments, the Persistent Images page in the PowerVault NAS Manager refreshes too quickly.	Wait a few seconds and refresh the page. You should see that the persistent image you deleted is no longer listed.

delete it again, I get a blank page.		
When I try to take a persistent image, a critical error message states that the snapshot could not be taken.	Dell ActiveArchive may still be deleting or restoring a volume or taking another snapshot.	Wait a few minutes for the previous process to complete and then try again.
In the event log or on the Status page, a message states: An exception has occurred. The data contains the exception record.	This is a known issue.	Ignore this message. The NAS system is functioning normally.
After restoring a volume from a persistent image, I cannot mount to a share on that volume from a Linux client.	During the restore, the volume is dismounted.	From the NAS Manager, restart NFS, and then remount to a share on the volume.
The % symbol does not show in the Dell ActiveArchive event logs.	Dell ActiveArchive event log messages that tell you how full the cache file is and how close the system is to the maximum allowed snapshots are generated messages. These messages do not include the % symbol.	Take no action. The NAS system is functioning as designed.

Table 8-5. Dell OpenManage Array Manager

Issue	Possible cause	Resolution
Two of the IDE hard drives show as SCSI drives in the Dell OpenManage Array Manager window and the Windows Device Manager window.	Your NAS system supports only IDE hard drives. The system is reporting the hard drive type incorrectly.	Take no action.
After repairing a volume in the NAS Manager, one or more disks show as "missing" in Array Manager.	The repair does not actually delete the disks, although the disks are displayed as missing.	Take no action. Your NAS system is still operating correctly.

Table 8-6. UNIX and Red Hat Linux

Issue	Possible cause	Resolution
I am unable to manage my disks and volumes from my Linux clients or from clients running the Netscape browser.	Managing disks and volumes from a Linux client or from any client that is running Netscape as its only browser is not supported.	Use a Windows client system with Microsoft Internet Explorer 5.01 or later to manage your disks and volumes.
I cannot access the Terminal Services Advanced Client through the NAS Manager from my Linux client system using the Netscape browser.	The Terminal Services Advanced Client is not supported by the Linux operating system and does not work with the NAS Manager.	Use a Windows client system to manage the NAS system through a Terminal Services Advanced Client session.
While updating client access to an NFS share, the No Access option is displayed, but the Root option is not.	Only the All Machines category options are displayed during this update.	Add the appropriate clients, and then select OK . After you have added the client, navigate back to the NFS tab for this share and select the correct options for the individual Client Machines .

<p>Every time I try to obtain a directory listing from an NFS client on the root of a system volume, I get an error message, such as Permission Denied.</p>	<p>The problem you are experiencing involves a System Volume Information directory created by Microsoft Index Server. The NFS service does not have access to this directory and returns an error message to the client when trying to list its properties.</p> <p>This issue only occurs when sharing the root of a drive letter.</p>	<p>Ignore this error. The System Volume Information directory is not used by NFS clients or your system by default.</p>
<p>Sometimes I am unable to delete folders that have been used and that are shared to an NFS client.</p>	<p>This is a situation that occurs with NFS discretionary access lists (DACLS) and inheritance. When the folder to be shared is created, the only access control entry (ACE) created by default is Everyone with Full Control. When an NFS client creates a directory or a file in this directory (mounted share), Services for UNIX (SFU) creates a new DACL that replaces the inherited Everyone with Full Control ACE. This DACL contains an Everyone ACE with the appropriate UNIX file creation access and may contain two other ACEs for the mapped user and group. If this happens, the administrator of the Windows client cannot delete the file or directory unless that administrator takes ownership through the Windows system and changes the access.</p>	<p>As the administrator, use a Windows client system to take ownership and change the access to allow yourself to delete the share folders.</p> <p>When you delete the NFS share folders, ensure that there are no open file handles for the share. If you are unsure, delete the share, and then restart NFS.</p>
<p>When updating client access to an NFS share, the All Machines client group is reset from the No Access access type to Read-Write access.</p>	<p>The NAS Manager might reset the All Machines client group to Read-Write when there are no clients that have read-only or read-write access.</p>	<p>Add a client that has read-write or read-only access, and then set the All Machines client group to No Access.</p>

Table 8-7. Macintosh and AppleTalk

Issue	Possible cause	Resolution
<p>I am getting event errors for Services for Macintosh.</p>	<p>Services for Macintosh are bound to the onboard network interface controller (NIC) by default. If this NIC has been disabled, binding errors occur.</p>	<p>Bind the AppleTalk protocol to an enabled NIC. See "AppleTalk Protocol Adapter Binding" in "Advanced Features."</p>
<p>From a Macintosh client, users cannot modify or delete a file that a Windows client has accessed.</p>	<p>The time between clients and the system is not properly synchronized.</p>	<p>Make sure that clients have their time synchronized to within 10 minutes of the time zone.</p>
<p>I have rebooted my NAS system from a Macintosh client. Several minutes have passed and my NAS system has not rebooted or the page has not refreshed.</p>	<p>The most likely cause is that the NAS system has come back online, but the client screen has not refreshed because the PowerVault NAS Manager does not automatically refresh the screen when the NAS system has finished rebooting.</p>	<p>Close Internet Explorer, and then reconnect to the NAS Manager. The NAS system should behave normally.</p>
<p>From a Macintosh client, I cannot connect to the administration part of the PowerVault NAS Manager by using the Administer This Appliance link on the HTTP Shares page.</p>	<p>The internally generated certificate is not supported by Internet Explorer for Macintosh.</p>	<p>You can administer the NAS system by using the address <code>http://servername:1278</code>; however, this is a nonsecure link.</p>
<p>After modifying properties of the</p>	<p>File Services for Macintosh can not establish</p>	<p>Restart the workstation</p>

AppleTalk protocol, File Services for Macintosh does not restart.

communication to the local RPC service.

service. See "[Restarting Workstation Services](#)" in "Advanced Features."

Table 8-8. Netscape Navigator

Issue	Possible cause	Resolution
I am unable to manage my disks and volumes from clients running the Netscape browser.	Managing disks and volumes from any client that is running Netscape as its only browser is not supported.	Use a Windows client system with Internet Explorer 5.01 or later to manage your disks and volumes.
I cannot use the Back button in Netscape Navigator for the online help in the PowerVault NAS Manager.	This feature is not supported.	Use the Previous Topic link to navigate back to earlier topics.
I get a password prompt when navigating through Local Groups in the PowerVault NAS Manager using Netscape Navigator on Linux.	The password prompt is generated by Netscape and does not require re-authentication. The administrator is being asked whether the password that was used to access this screen should be saved.	Select Do not Prompt Me Again , and this message will not display in the future.
I am using Netscape Navigator to administer my NAS system through the PowerVault NAS manager. A long gray bar at the bottom of the screen is covering the OK and Cancel buttons.	The page has not finished loading.	Use one of the following resolutions: <ul style="list-style-type: none">• Wait for the page to finish loading.• Refresh the page several times.

[Back to Contents Page](#)